

# OWNERS MANUAL

OPERATION & ASSEMBLY INSTRUCTIONS  
AND  
WARRANTY INFORMATION

FOR ALL 6 SIDED

**SUN**  **CAPSULE**

**TANNING SYSTEMS**

CREATIVE MARKETING CONCEPTS, INC. 96 AUDUBON ROAD, WAKEFIELD, MA 01880 TEL: (800) 272-8267 FAX: (978) 532-8168 WWW.SUNCAPSULE.COM

**IMPORTANT: Warranty Card on back page must be completed and mailed within 10 days from date of delivery**

## F.D.A. Notice Important

The F.D.A. requires that this manual remain in your business at all times.

It must be made available to any F.D.A. official during an inspection of your establishment.

Always read and follow all instructions for the proper usage before operating your Sun Capsule tanning system.

Follow the exposure schedule based on the individual's skin type. Failure to do so may result in over-exposure.

The Sun Capsule is designed to be used by only one person at a time.

This manual contains instructions for repairs, recommended replacement components and accessories which are compatible with products, including compatible protective eyewear, ultraviolet lamps, timers and reflectors, which will, if installed or used as instructed, result in continued compliance with the standard. The manufacturer of the equipment is:

Creative Marketing Concepts, Corp.

96 Audubon Road

Wakefield, MA 01880

Tel: 978/532-7517

Fax: 978/532-8168

THIS EXPOSURE SCHEDULE IS SPECIFIC TO THE SUNCAPSULE CYCLONE 60 LAMP  
220WT VHR

**DANGER** - Ultraviolet radiation. Follow instructions. Avoid overexposure. As with natural sunlight, overexposure can cause eye and skin injury and allergic reactions. Repeated exposure may cause premature aging of the skin and skin cancer.

**WEAR PROTECTIVE EYEWEAR: FAILURE TO DO SO MAY RESULT IN SEVERE BURNS OR LONG-TERM INJURY TO THE EYES.**

Medications or cosmetics may increase your sensitivity to the ultraviolet radiation. Consult a physician before using sunlamps if you are using medications or have a history of skin problems or believe yourself especially sensitive to sunlight. If you do not tan in the sun, you are unlikely to tan from the use of this product"

For your information

Recommended exposure position

The "FOOT PLACEMENT" indicators are located to give you the best overall tan in the shortest period of time. To achieve recommended exposure positions, place feet on indicators. The use of any other position may result in over-exposure.

<b>RECOMMENDED EXPOSURE SCHEDULE</b>					
<b>SKIN TYPE</b>	<b>WEEK1 1ST-3RD SESSIONS</b>	<b>WEEK 2 4TH-6TH SESSIONS</b>	<b>WEEK 3 7TH-10TH SESSIONS</b>	<b>WEEK 4 11TH-15TH SESSIONS</b>	<b>WEEKLY SUBSEQUENT SESSIONS</b>
II - FAIR	2 MINUTES	3 MINUTES	5 MINUTES	6 MINUTES	8 MINUTES
III - AVERAGE	2 MINUTES	3 MINUTES	5 MINUTES	7 MINUTES	8 MINUTES
IV - BROWN	3 MINUTES	4 MINUTES	6 MINUTES	7 MINUTES	8 MINUTES
V - DARK BROWN	4 MINUTES	6 MINUTES	7 MINUTES	8 MINUTES	8 MINUTES

TANNING SESSIONS SHOULD BE LIMITED TO ONCE EVERY 48 HOURS. AN APPEARANCE OF TANNING NORMALLY APPEARS AFTER A FEW EXPOSURES AND MAXIMIZES AFTER (4) WEEKS OF EXPOSURE FOLLOWING RECOMMENDED SCHEDULE FOR YOUR SKIN.

**INSTRUCTIONS ACCOMPANYING THIS PRODUCT SHOULD ALWAYS BE FOLLOWED TO AVOID OR MINIMIZE POTENTIAL INJURY**

Dear Sun Capsule® Owner,

Congratulations. You have just purchased the finest, most advanced, ultra-high performance vertical tanning system the industry has to offer.

Enclosed you will find very important information regarding the safe operation of your Sun Capsule. Please read it carefully.

If you follow the recommended procedures for care and daily maintenance you can expect a lifetime of performance and profits from your Sun Capsule.

Anything less than the proper care can decrease the performance of your system and, in some cases, void your warranty.

On the rare occasion you have a problem with the operation of your Sun Capsule, please refer to the trouble shooting section before calling for service. Usually it is something simple and it will save time if a few quick checks have been performed before calling Creative Marketing Concepts.

Most importantly, when you have a question regarding the Sun Capsule, please do not hesitate to call us at 978-532-7517.

We are here to help you make your Sun Capsule the most successful profit center within your business.

Sincerely,

A handwritten signature in black ink, reading "Eugene G. Charette". The signature is fluid and cursive, with the first name being the most prominent.

Eugene G. Charette, C.E.O.  
Creative Marketing Concepts, Corp.

F.D.A. Notice

---

# T A B L E O F C O N T E N T S

---

FDA Notice .....	1
Exposure Schedule .....	2
Congratulations .....	3
Table of Contents .....	4
OWNERS MANUAL .....	5
TANNING PRECAUTIONS .....	5
Photosensitive drug list (partial) .....	5
Allergic Reactions .....	6
Pregnant Women .....	6
Children .....	6
Protective Eye Goggles .....	6
Protective Guards .....	6
UNDERSTANDING YOUR SYSTEM .....	6
Daily Maintenance .....	6
Timer Operation .....	6
Connecting a Data Base to the Sun Capsule .....	7
Hour meter .....	7
Emergency Entry Key .....	7
Changing Overhead Light .....	7
Peak Performance .....	7
Venting/Ducting of Fan .....	8
Changing Starters .....	8
Lamp End Blackening .....	8
Proper Lamp Installation .....	8
Lamp Replacement .....	8
Tanning The Lower Legs .....	9
Indoor Tanning Lotions, Oils and Moisturizers .....	9
Lamp Rotation – 48 Lamp System .....	10
Lamp Rotation – 54 Lamp System .....	11
Lamp Rotation – 60 Lamp System .....	12
Assembly Instructions Table of Contents .....	13
ASSEMBLY INSTRUCTIONS .....	14
Lamp Fixture Wiring Diagrams .....	30
System Schematics .....	33
Trouble Shooting Guide .....	35
Warranty and Warranty Card .....	38

# Owners Manual

## TANNING PRECAUTIONS

**PHOTOSENSITIVE DRUGS** –The following is a partial list of some of the photosensitive drugs on the market. It is your responsibility to be aware of any customer using any drug considered photosensitive. These individuals under the influence of this type of drug can experience adverse effects and should avoid exposure to UV sources of all kinds. Doctors will advise persons taking these medications of possible adverse effects.

### **DANGER:**

**If you have been diagnosed by a doctor as being allergic to the sun or are currently taking photosensitive medications, consult your physician before using the Sun Capsule.**

### **IMPORTANT INFORMATION BEFORE YOU TAN**

Certain drugs do not mix well with ultraviolet light, either in its natural source or artificial. Below is a list of drugs, foods, and other substances which could make your skin super sensitive to sunlight;

**Diuretics:** To aid in water retention, also prescribed for high blood pressure. (For example: Hydrodiuril)

**Diabetes Drugs:** Orinase and Diabinese.

**Urinary Tract Infection:** Treatments with Phenstiazines.

**Tranquilizers:** such as Thorazine.

**Antihistamines:** Phenergan and Benadryl, particularly when used on the skin in ointment form.

**Antibiotics:** Declomycin, Aureomycin, and Griseofulvin, a drug used in the treatment of ringworm.

**Coal Tar Treatment:** for Psoriasis or chronic Eczema.

**Bacterial infection:** treatments using Sulfanilamide.

**Compounds known as furocoumarins or psoralens: which sensitize skin to sunlight.** They are prescribed for vitiligo (loss of skin pigmentation) and Psoriasis.

Anesthetics	Diethylstilbestrol	Orabetic Orinase	TBS	Vesprin
Aresicals	Dilantin	Pacatal	TCSA	
Aureomycin	Diuretics	Pheynibuzatone	Termail	
Barbiturates	Diuril	Procaine	Terramycin	
Benzedyl	Dyes	Psoralen Drugs	Tetracyclines	
Compazine	Estrone	Pyrrolazote	Therahistin	
Cold & Silver Salts	5 Fu	Quinine	Thiazide	
Dartal	Griseofulvin	Salicyclates	Thorazine	
Declomysin	Hydrodiuril	Sparine	Tridione	
Diabinese	Nadison	Sulfanamides	Trilafon	

Coal Tar Products & Essential Oils: Bergamont, Cedar, Lime Lavender and Vanillin.

**ALLERGIC REACTIONS TO UV** – Some people may experience a reddening of the skin, usually contained to small areas of the body, such as arms, stomach area, etc., usually accompanied by an itching sensation. In many cases it may be nothing more than heat rash. In some cases it may be an allergic reaction to UV exposure, usually as a result of too much exposure in a given period of time for that particular skin type. You should be alert to any customer complaints pertaining to this and instruct the customer to avoid tanning, indoors or outdoors, until the symptoms have disappeared, usually within 24 hours. Once the customer resumes tanning, reduce the exposure schedule until their body has acclimated to the tanning process.

**PREGNANT WOMEN** –The only 100% safe answer to this question is to discourage expectant mothers from using the tanning system, unless they have a letter from their doctor.

**CHILDREN** – A good policy to adopt is; No children under 18 years of age without written consent from a parent, unless there are laws in your state or county that indicate otherwise. Keep young children away from the Sun Capsule. It is not a toy. The sunlamps are breakable and potentially dangerous.

**PROTECTIVE EYE GOGGLES** – Every customer must wear protective eyewear during a tanning session. One pair of goggles is provided with each Sun Capsule. It is advisable that each customer owns a pair of protective eyewear. This is the most sanitary (and profitable) way to conduct your business.

It is advisable to remove contact lenses before each tanning session due to the dryness of the air.

**PROTECTIVE GUARDS** – DANGER: Keep hands and fingers away from protective fan guards, lamp guards and lamps. Serious injury and/or severe burns may result.

## **UNDERSTANDING YOUR SYSTEM**

**DAILY MAINTENANCE** –Your Sun Capsule has been designed to be virtually maintenance free. Since the only body parts that come in contact with the system are the bottoms of the feet, close attention should be paid to this area on a daily basis. The floor can be wiped down with warm water and Lysol (1 gallon water to 3 teaspoons Lysol) or any other mild disinfectant solution you choose. This procedure should be performed as necessary, depending on traffic flow.

**CAUTION:** Clean Fast Flow Floor vent with damp cloth only. Avoid excess cleaning fluid dripping through the vent holes. Make sure floor is dry before next tanning customer enters booth.

Over time, the hand straps will become soiled. They can be removed and washed with warm soapy water.

The walls, ceiling and framework can be cleaned with any mild NON-ABRASIVE cleaner and a soft cloth. Ivory liquid and warm water works well. **DO NOT ALLOW WATER OR ANY LIQUID CLEANERS TO COME IN CONTACT WITH THE FLUORESCENT SOCKETS OR SUNLAMPS.**

**DANGER** – Never service the fan without first unplugging fan motor from junction box and shutting off power to the Sun Capsule. The fan blade should be cleaned when any noticeable build-up of dust is noted. On 160 Watt and 200 Watt Sun Capsules remove the grill from inside the booth and carefully wipe down the fan blades (use extreme caution, the edges of the blade are sharp) and surrounding grillwork. On 220 Watt Sun Capsules, carefully remove the upper fan assembly by removing 4 screws holding it in place. Be careful not to bend blades when removing or re-installing.

The lamps and guards can be cleaned using a vacuum cleaner with a soft furniture duster attachment.

Periodically, the lamps should be removed and wiped clean. **NEVER USE ABRASIVE CLEANERS** anywhere in the Sun Capsule.

**ACRYLIC FRONT PANELS ONLY** –When cleaning the wall panels do not use anything except Brilliance or equivalent high quality acrylic cleaner with a soft cloth. Use of products, such as Windex or paper towels, will result in damage to the panels and void warranty.

**TIMER OPERATION** –Your digital timer is solid state in design, giving you years and years of accurate and reliable timer settings. If you add a timer cord longer than 90' in total length, a transformer will be necessary to boost the 24 volt signal from the booth to the timer.

### **If using the timer in stand alone use:**

Setting the Timer – After each session, your digital timer will read "0". To enter session time, simply press the ^ button until the desired time appears in the "window". If you go past the desired time, keep pressing the ^ button until the correct time is reached.

Starting the Tanning Session –The tanning session can be activated in two ways. (1) You can press the “START/STOP” button on the timer, or (2) your customer can press the “START” button in the Sun Capsule when they are ready to start tanning. #2 is the recommended procedure.

Stopping the Tanning Session –The tanning session can be terminated in two ways. (1) Press the “START/STOP” button on the timer. (2) the customer can place the “EMERGENCY SHUT OFF SWITCH” on the panel in the Sun Capsule to the “OFF” position. Note: Both these methods will terminate the tanning session but the time will continue to count down. If the customer decides to place the “EMERGENCY SHUT OFF” switch in the “ON” position, the tanning session will be reactivated, if there is still time remaining on the digital read-out.

**IMPORTANT** – “Emergency Shut Off” switch must be in the “ON” position before the Sun Capsule can be reactivated.

**If using the timer with a database system:**

Your Sun Capsule timer is compatible with most popular database systems. The Sun Capsule timer port for the daisy chain connection to the database takes a CAT-5 cable. If requested, this cable is supplied with your Sun Capsule timer. The CAT-5 cable, along with an adaptor and the RJ22 cable, joins in your daisy chain line the same as all your other equipment.

When using the Sun Capsule timer with a database system the database over rides any manual control of the timer. Therefore, you will only be able to set time to the Sun Capsule through your database system.

**HOURLY METER** –The hour meter is located on the control panel above the “LIGHT” switch. It is non-resettable. It will allow you to keep track of total hours as well as when to change or rotate your sun lamps.

**NOTE:** The last digit is in “tenths” of 1 hour. It is easier to ignore the last digit and read only full hours. Example: 00015.2 is actually a little more than 15 hours.

**EMERGENCY ENTRY KEY** –The Emergency entry Key is on a chain (to prevent loss or misplacement) on top of the booth, mounted to the ceiling above the door.

**CHANGING OVERHEAD LIGHT** – Do not exceed 10 watt, 12 volt bulb. **NOTE:** If you have the optional Illumination Package, a 50 Watt MR16, 12 Volt Lamp is required. Keep fingers from touching replacement bulb.

**PEAK PERFORMANCE**

Your Sun Capsule is the fastest vertical tanning system on the market today. It is a finely tuned, ultra-high performance tanning system, but you must be aware of the following factors that affect the tanning capabilities of the system.

**VOLTAGE:** Your system requires a minimum of 230 volts. A running voltage between 230 to 235 volts is required to attain peak performance. Please factor in the effect of other equipment running in the salon at the same time. In most cases a buck boost transformer will be necessary to achieve proper running voltage.

**PROPER COOLING IS THE KEY TO PEAK PERFORMANCE AND LONG LAMP LIFE.**

**ROOM TEMPERATURE:** Optimum performance can only be attained provided you supply adequate cooling to the system to begin with. To insure the highest output from your system, your room temperature should be between 73°F and 80°F. Room temperatures higher than or lower than the above temperatures may adversely affect the performance of the lamp. In the case of higher room temperatures, lamp life can be decreased as well.

Do not obstruct wall panel intake ports.

Do not feed air-conditioned air directly into the Sun Capsule. This will cause over-cooling of the lamps and reduced performance.

Keep the unit at least 6 inches away from any wall or obstruction and 12” from another Sun Capsule or tanning system. Air must be allowed to flow freely into the unit through the Fast Flow Floor Vent.

**FAN OPERATION:** Your Sun Capsule cooling fan is equipped with an adjustable delay timer that is preset at the factory for approximately 4 minutes. This allows for proper lamp cool down after each session. Anytime the Sun Capsule is energized, the 4 minute fan delay will be automatically activated.



**VENTING/DUCTING OF FAN** – It is important to keep the ambient temperature in the vicinity of the Sun Capsule between 73 F – 80 F. If you have very high ceilings or if your Sun Capsule sets in a very large open area, it may not be necessary to vent the exhaust air from the fan.

If you have low ceilings or the Sun Capsule is in an enclosed room, it is important to employ a ducting system to remove the hot air.

If you have a “suspended” ceiling with a generous amount of dead air space above, the least expensive way of removing the hot air would be to fabricate a duct that would enclose the space between the fan motor grill and the suspended ceiling, allowing the air to fill the dead air space. See diagram.

**IMPORTANT: Do not choke or restrict the airflow from the fan with ducting.** Any reduction of airflow from cooling fan will result in a decrease in performance, overheating and potential damage to the VHR sunlamps.

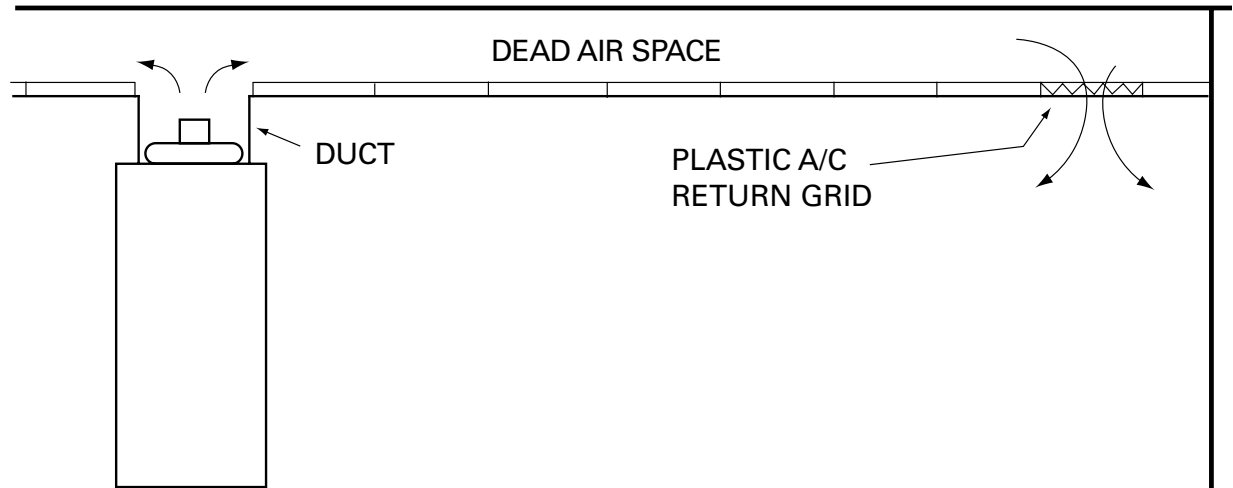

You must take some things into consideration when doing this. First you must have a way to get rid of the hot air in the dead air space or back pressure will build up, causing the temperature to rise in the Sun Capsule.

To accomplish this, install plastic A/C return grids near A/C ducts in your salon, allowing the air from the dead air space to filter down throughout your salon and mix with conditioned air.

If your Sun Capsule is in an enclosed room, you must make sure that you bring air into the room as fast as you take it out. This can be done with a full louvered door leading into the enclosed room. Keep in mind, whatever you do, you must replace the air being taken out of the room with an equal amount of fresh air.

Another method is to install more A/C. To determine the proper amount of A/C, consult your HVAC expert. Give them the total number of sunlamps and wattage of your specific model. That information will help them recommend what the best solution is for your given situation. Do not feed conditioned air directly into the Sun Capsule.

**CHANGING STARTERS** –Your Sun Capsule is equipped with electronic starters that carry a 10 year warranty from the manufacturer of the starters. Should a starter fail within that time period, the starter will be replaced free of charge according to warranty procedure.

**LAMP END BLACKENING** – Due to the high operating temperatures of the VHR sunlamps, lamp end blackening will occur. This does not adversely affect performance.

**PROPER LAMP INSTALLATION** –The manufacturing process of a sun lamp creates a phosphor coating that is slightly thicker at one end of the lamp than the other. By installing every other lamp with the manufacturer’s label at the “top” (and every other lamp with the label at the bottom) a more uniform UV output will be attained.

## LAMP REPLACEMENT

**REMOVING LAMP GUARDS:** Each lamp guard is fastened to each lamp fixture with two fasteners at the top, two in the middle and two hooks at the bottom. Using a Phillips head screwdriver, back out the four fasteners and gently raise the lamp guard up and away from the lamp fixture.

**REMOVING LAMPS:** Rotate lamps until pin aligns with opening in socket. Be careful not to bend or break pins when removing lamps.

**LAMPS FOR LIFE FOR LESS™:** When you purchase a Sun Capsule you are automatically enrolled in Sun Capsule's Lamps For Life For Less™ program giving you access to the absolute lowest prices for all your lamp needs. Call **1-800-272-8267** for details.

**INSTALLING LAMPS:** Start by placing bi-pins in bottom socket, making sure to line up pins with slot on bottom socket. Next, insert top bi-pins in slot in top socket. Rotate lamp 90 degrees, making sure lamp socket is locked in place at both ends.

**VERY IMPORTANT:** Each VHR® lamp has a reflector built into the lamp. The reflector encompasses the solid white portion of the lamp. This must be rotated to the rear, enabling all UVA/UVB to be directed toward the customer.

**When lamp is properly installed, label will be facing you.**

**INSTALLING LAMP GUARDS:** Before you install lamp guards, make sure all lamps are working properly. Position lamp guard on the lamp fixture by inserting the hooks at the bottom of the lamp guard into the appropriate slots at the bottom of the fixture. Push the lamp guard down until the top holes in the lamp guard align with the top holes in the fixture. Align and insert the fasteners into threaded inserts and tighten securely.

**TANNING THE LOWER LEGS** – For some people the lower legs may tan slower than the rest of the body. Suggest to the customer that a wider stance (legs close to the left and right fixtures) will accelerate the tanning of the lower legs.

**INDOOR TANNING LOTIONS, OILS AND MOISTURIZERS** – You should carry at least one or two lines of top quality indoor tanning products. A good pre-tan base gel is recommended during the first week of tanning. After a base tan has been achieved, usually 4-5 sessions, an accelerator or amplifying lotion or oil can be used to enhance the tanning process.

Moisturizers should be encouraged throughout the tanning program. They should be applied after tanning. A lip protector should be used during tanning since the lips have no ability to produce melanin for protection.

**REMEMBER:** The tan produced by the Sun Capsule is a rich dark cosmetic tan. Make sure your customers understand that AN INDOORTAN WILL NOT PROVIDE ADEQUATE PROTECTION AGAINST OVER-EXPOSURE TO NATURAL SUNLIGHT.

**CAUTION:** Your system is equipped with a Fast Flow Floor Vent. It is advisable to avoid any spray-type lotions or oils. The vaporized lotions will be carried throughout the tanning system via the rapidly moving air passing through the vent, resulting in slippery floors and cause for frequent clean up.

**LAMP ROTATION (48 lamp system)** - From the moment a new sun lamp is energized, it begins a gradual decrease in performance. VHR lamps tend to last approximately 500 to 600 hours. There are a few different ways to change lamps.

The most simple method is to let the lamps reach their life expectancy and then change all of the lamps at one time. The drawback to this method lies in the fact that by the time you change your lamps, they have all reached their maximum life expectancy.

A more efficient method is through a lamp rotation process. This can be accomplished in any number of ways. The following example applies to the 48 lamp Sun Capsule VHR and will take you through 3 rotations. After the fourth rotation, it will become easier because you will no longer have to save the original lamps, as they will have 600 hours of use and will be discarded. Then it becomes a matter of simply inserting 16 new lamps in section 1 and moving the remaining lamps to the left and right of center. This rotation system can be adapted to any Sun Capsule VHR by dividing the number of lamps by 3 to obtain the number of lamps in each rotation.

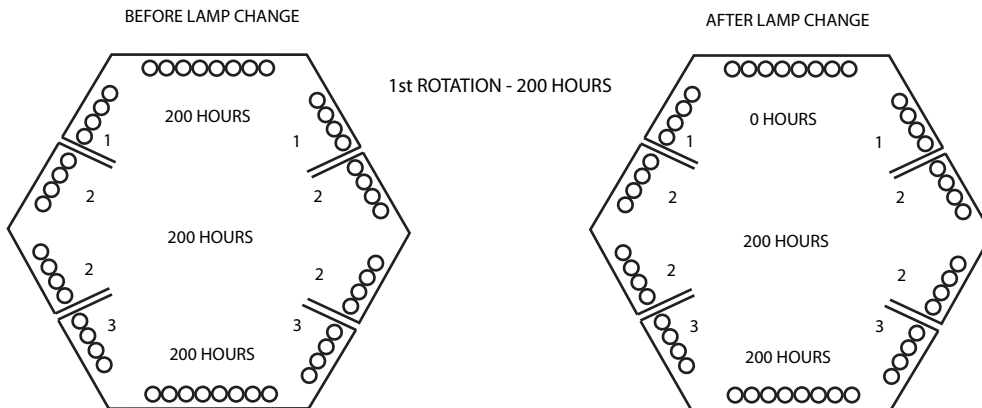

Step 1. Remove 16 lamps from section 1. Mark them "200 hours". Put aside for second rotation.  
 Step 2. Install 16 new lamps in section 1.

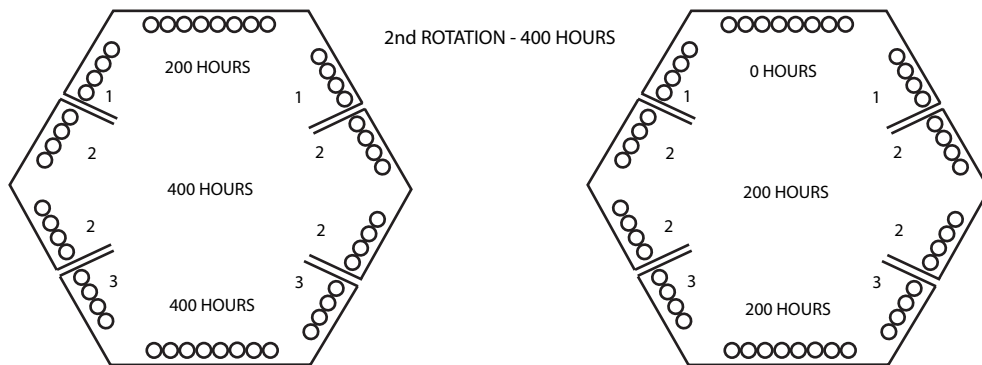

Step 1. Remove lamps in sections 2 and 3. Mark them "400 hours". Step 2. Move section 1 to section 2.  
 Step 3. Install 16 new lamps in section 1. Step 4. Install "200 hour" lamps from 1st rotation in section 3.

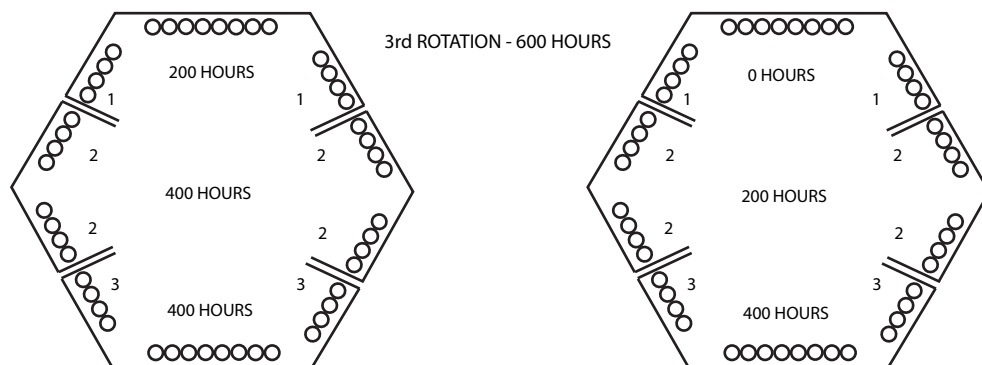

Step 1. Remove lamps in section 2 and mark them "400 hours". Step 2. Move lamps from section 1 to section 2.  
 Step 3. Install 16 new lamps in section 1.

**LAMP ROTATION (54 lamp system)** - From the moment a new sun lamp is energized, it begins a gradual decrease in performance. VHR lamps tend to last approximately 500 to 600 hours. There are a few different ways to change lamps.

The most simple method is to let the lamps reach their life expectancy and then change all of the lamps at one time. The drawback to this method lies in the fact that by the time you change your lamps, they have all reached their maximum life expectancy.

A more efficient method is through a lamp rotation process. This can be accomplished in any number of ways. The following example applies to the 54 lamp Sun Capsule VHR and will take you through 3 rotations. After the fourth rotation, it will become easier because you will no longer have to save the original lamps, as they will have 600 hours of use and will be discarded. Then it becomes a matter of simply inserting 18 new lamps in section 1 and moving the remaining lamps to the left and right of center. This rotation system can be adapted to any Sun Capsule VHR by dividing the number of lamps by 3 to obtain the number of lamps in each rotation.

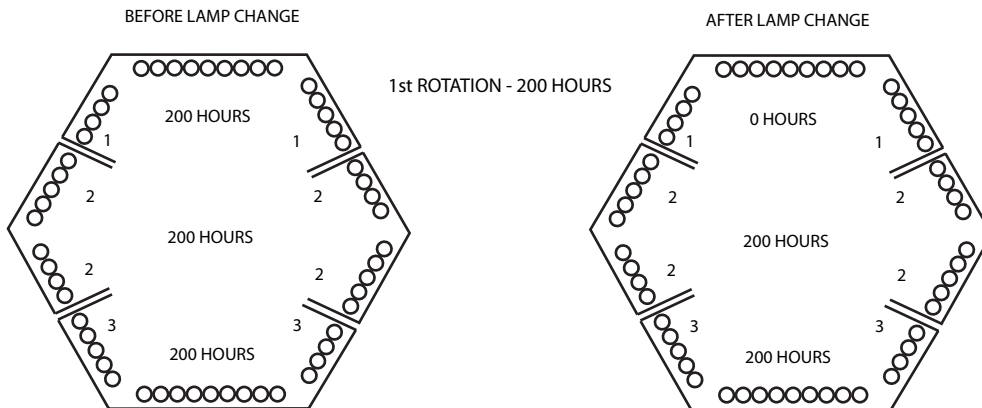

Step 1. Remove 18 lamps from section 1. Mark them "200 hours". Put aside for second rotation.  
 Step 2. Install 18 new lamps in section 1.

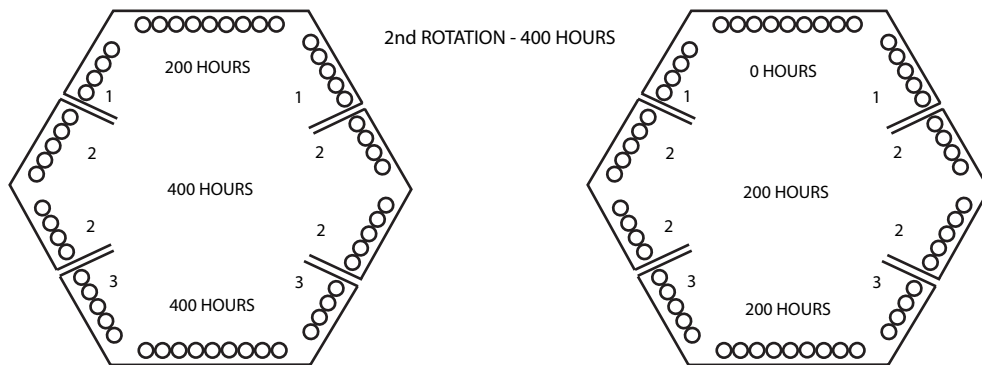

Step 1. Remove lamps in sections 2 and 3. Mark them "400 hours". Step 2. Move section 1 to section 2.  
 Step 3. Install 18 new lamps in section 1. Step 4. Install "200 hour" lamps from 1st rotation in section 3.

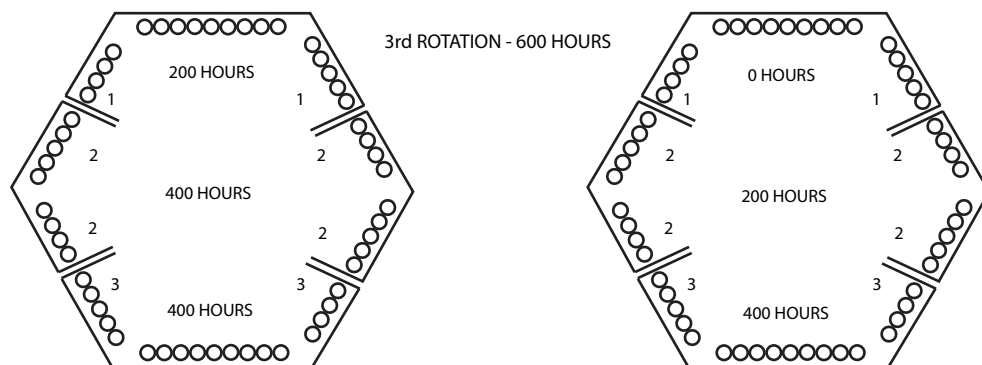

Step 1. Remove lamps in section 2 and mark them "400 hours". Step 2. Move lamps from section 1 to section 2.  
 Step 3. Install 18 new lamps in section 1.

**LAMP ROTATION (60 lamp system)** - From the moment a new sun lamp is energized, it begins a gradual decrease in performance. VHR lamps tend to last approximately 500 to 600 hours. There are a few different ways to change lamps.

The most simple method is to let the lamps reach their life expectancy and then change all of the lamps at one time. The drawback to this method lies in the fact that by the time you change your lamps, they have all reached their maximum life expectancy.

A more efficient method is through a lamp rotation process. This can be accomplished in any number of ways. The following example applies to the Sun Capsule 60 lamp systems and will take you through 3 rotations. After the fourth rotation, it will become easier because you will no longer have to save the original lamps, as they will have 600 hours of use and will be discarded. Then it becomes a matter of simply inserting 20 new lamps in section 1 and moving the remaining lamps to the left and right of center. This rotation system can be adapted to any Sun Capsule system by dividing the number of lamps in the system by 3 to obtain the number of lamps in each rotation.

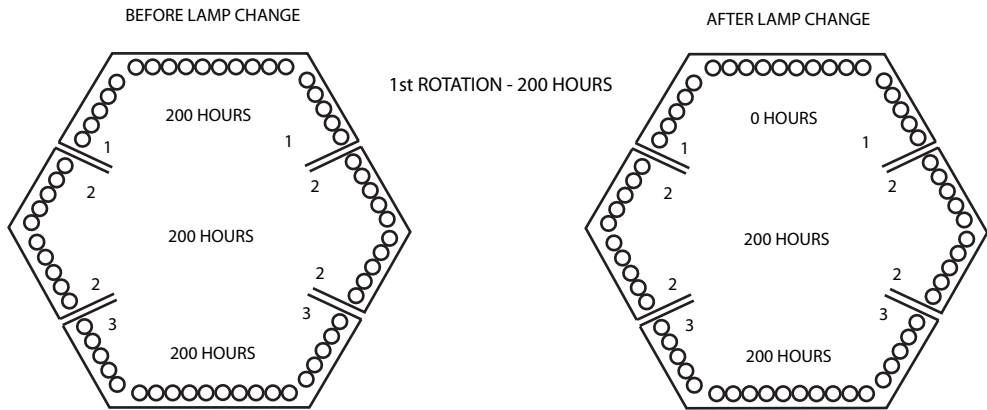

Step 1. Remove 20 lamps from section 1. Mark them "200 hours". Put aside for second rotation.  
 Step 2. Install 20 new lamps in section 1.

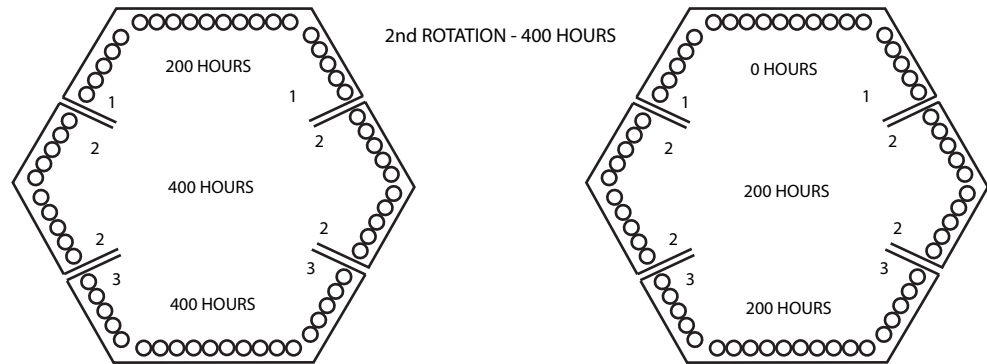

Step 1. Remove lamps in sections 2 and 3. Mark them "400 hours". Step 2. Move section 1 to section 2.  
 Step 3. Install 20 new lamps in section 1. Step 4. Install "200 hour" lamps from 1st rotation in section 3.

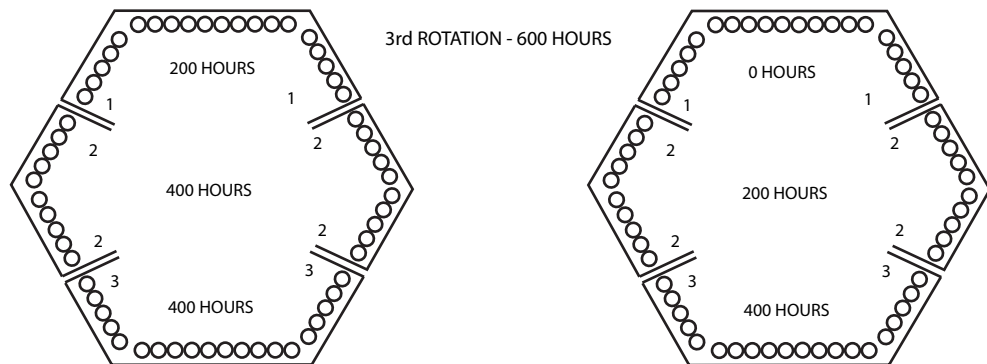

Step 1. Remove lamps in section 2 and mark them "400 hours". Step 2. Move lamps from section 1 to section 2.  
 Step 3. Install 20 new lamps in section 1.

---

# ASSEMBLY INSTRUCTIONS TABLE OF CONTENTS

---

Introduction . . . . .	14
Very Important . . . . .	15
ReadyTo Begin . . . . .	16
Attaching Wall Panel Standoffs . . . . .	17
Inserting Wall Panels In Corner Pieces . . . . .	17
Ceiling Installation . . . . .	21
Installing Inside Fan Guard . . . . .	21
Lamp Fixture Installation . . . . .	22
Installing #6 Lamp Fixture - 220Watt SCII Only . . . . .	23
Installing #6 Lamp Fixture 160/200Watt SCII Only . . . . .	24
Threshold Installation . . . . .	25
Door Assembly Installation . . . . .	25
Installing #6 Lamp Fixture - Sun Capsule I Only . . . . .	25
Installing Grab Bar to #6 lamp fixture . . . . .	25
Installing Fan Shut Off Switch . . . . .	25
Installing Fan . . . . .	27
Installing Overhead Light . . . . .	27
Mounting Junction Box . . . . .	27
Speaker and Stereo Hookup . . . . .	28
Final Adjustments . . . . .	28
Peak Performance Voltage . . . . .	29
Wiring Diagrams . . . . .	30
System Schematics . . . . .	33
Trouble Shooting Guide . . . . .	35
Warranty and Warranty Card . . . . .	38

# ASSEMBLY INSTRUCTIONS

## 6 Sided Sun Capsule Tanning Systems

With and Without Attached Dressing Rooms

### IMPORTANT

A voltage between 230 to 235 volts\* is required WHEN THE UNIT IS RUNNING to attain peak performance. Most salons experience a voltage drop of approximately 6 to 7 volts when the unit is in use. Also factor in the effect of other equipment running in the salon at the same time. A buck-boost transformer may be required to provide optimum voltage.

\*Export Systems Only: 50 Hz systems must operate between 220 volts and 225 volts.

**NOTE:** An insulated earthing conductor that is identical in size, insulation material and thickness to the earthed and unearthed branch – circuit supply conductors except that it is green with or without one or more yellow stripes is to be installed as part of the branch circuit that supplies the unit or system. The earthing conductor described is to be connected to earth at the service equipment, or if supplied by a separately derived system, at the supply transformer or motor – generator set.



“Unit must be wired by an authorized electrician in accordance with the National Electrical Code, ANSI/NFPA 70-1987, as well as all local codes.”

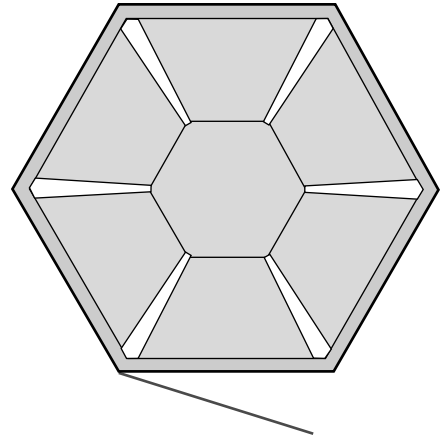

Sun Capsule I (Without Attached Dressing Room)

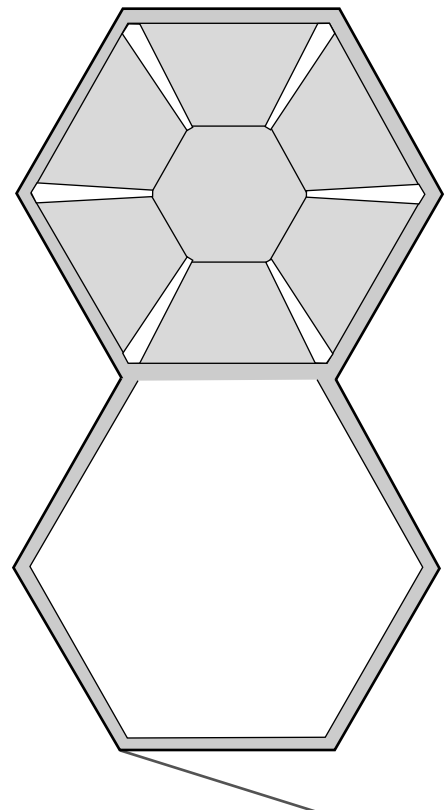

Sun Capsule II (With Attached Dressing Room)

# VERY IMPORTANT

## READ THE FOLLOWING BEFORE YOU BEGIN ASSEMBLY.

Take the time to familiarize yourself with certain components that make up the Sun Capsule before you attempt to assemble the unit.

The following photos will illustrate the procedure for assembling the Sun Capsule I and Sun Capsule II. The photos show the assembly of a Sun Capsule II, but the procedure is basically the same for both models.

The only difference between the Sun Capsule I and the Sun capsule II is the II has an attached dressing room.

The new modular design Sun Capsule tanning units have been engineered to be just about "Murphy proof" if you read the assembly manual.

The photos concentrate on the assembly of the shell, and some inherent problems and solutions that may be encountered during installation.

The surface that the unit is to be assembled on will determine the degree of difficulty during assembly. If the surface is basically flat and level, the assembly is usually quite simple. Unfortunately, some surfaces are not level.

Although one person can assemble a Sun Capsule I, the Sun Capsule II will require temporary assistance from a second person when handling the floor and ceiling. It may seem awkward at first, but once you've learned the "tricks-of-the-trade", assembly should be effortless.

The Sun Capsule I has 5 wall panels with ventilation ports designed to aid in the cooling of the sunlamps. Note that some of the ventilation ports are higher than the others (Figure 1A). It is extremely important that they are installed in the correct order for proper staggering of the lamp fixtures (Figure 1B).

The Sun Capsule II has 9 wall panels. 5 panels are identical to the Sun Capsule I mentioned above. 4 solid wall panels are used to create the dressing room portion of the unit. One of the solid panels has two pre-drilled holes for mounting double coat hook. Make sure panel is positioned with pre-drilled holes closest to the ceiling (Figure 1C).

The Sun Capsule II contains two "reverse bend" corner pieces. These are used at the mid-points of the booth. Set these aside until needed (Figure 1C).

Panel with retaining magnet mounting hole: One panel has one pre-drilled hole for the retaining magnet. Make sure panel is positioned with hole closest to ceiling in exact location as shown in Figure 1C.

The Sun Capsule I has 6 framework corner pieces that hold the wall panels in place. The Sun capsule II has a total of 10 framework corner pieces that hold the wall panels in place.

**IMPORTANT:** Examine all framework corner pieces. Two corner pieces have three (3) pre-drilled holes for hanging the door assembly. Set these aside and use them at the front of the booth where the door opens.

The dress plate on fixture #5 is covered with clear vinyl. Remove before assembly.

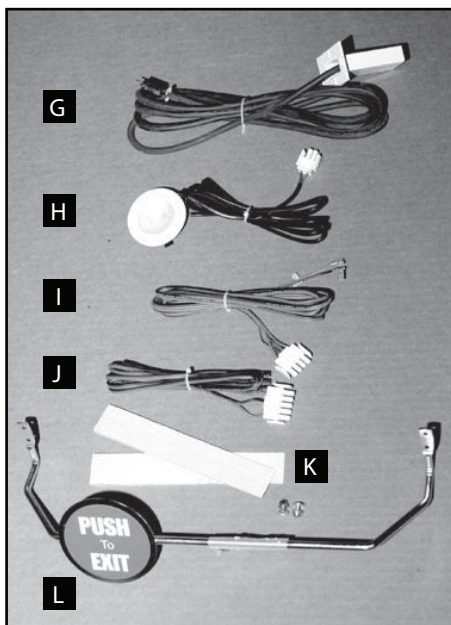
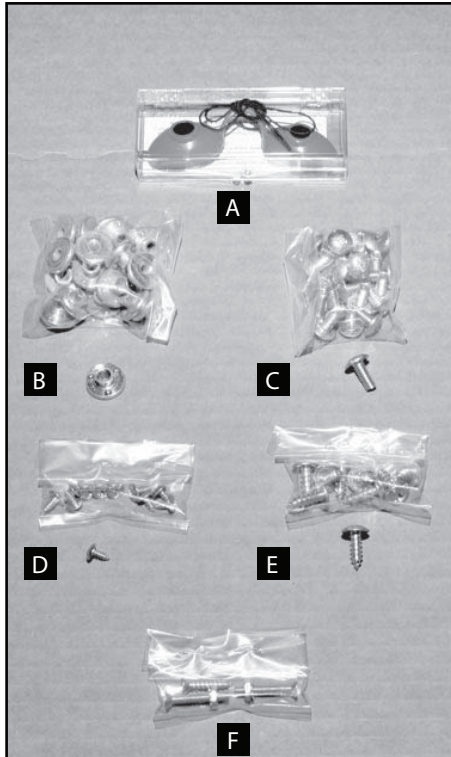

### HARDWARE LIST

- A. Protective Eye Wear (1 pair)
- B. Stand Offs for Lamp Fixture Mounting (20)
- C. Stand Off Mounting Bolts 1/4-20 x 1" Phillips Truss head bolts (20)
- D. Hardware for Dress Plate and Door Assembly #8 x 3/8" Sheet Metal Screws (10)
- E. Fan Screws #14 x 3/4" Phillips Pan Head (8)
- F. Threshold/Kick Plate Hardware 10-32 Machine Screw & Lock Nut (2) #10 Sheet Metal Screw (1)
- G. Fan Shut Off Switch with Cord
- H. 12 volt Overhead Courtesy Light
- I. 4 Pin Speaker Wire
- J. 5 Pin Timer Interface Cable
- K. Shims
- L. Grab Bar with Hardware Sun Capsule II Only
- M. Inside Door Handle with Hardware
- N. Double Coat Hook and Hardware
- O. Retaining Magnet, Washer & Hardware
- P. Hinge Pins and Sleeve
- Q. 160/200Watt Only: Stop Pin and Hardware White, Decorative Plastic Plugs (4) for the Back of the #6 Fixture

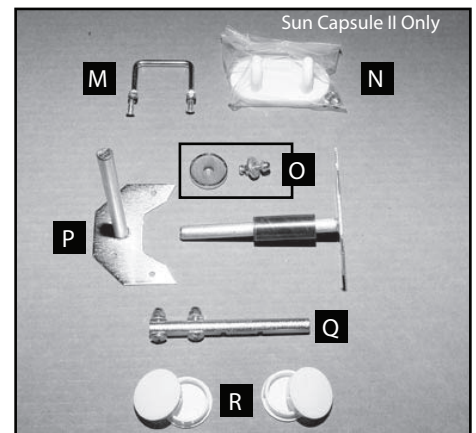



## READY TO BEGIN

**IMPORTANT:** Do not remove protective cardboard from Fast Flow Floor Vent™ until booth is completely assembled.

**FLOOR SAVER TEMPLATE:** Included with your system is a 1/8" masonite template that closely resembles the shape of your Sun Capsule. Its purpose is to protect your carpet or flooring from the effects of the UV light that filters through the vents in the Fast Flow Floor.

Place the template, smooth side up, in the exact spot your Sun Capsule will occupy once it has been assembled. See Figure 2. For proper cooling of the high performance tanning lamps (and your customers) your Sun Capsule must be kept a minimum of 6" away from any wall or obstruction. Keep in mind the template is 3 inches smaller all the way around than the actual size of the Sun Capsule. Therefore the template must be kept a minimum of 9 inches away from any wall or obstruction (Figure 3).

**FLOOR ASSEMBLY:** Center floor assembly on Floor Saver Template. (Figure 4). Do not remove protective cardboard until entire assembly is completed.

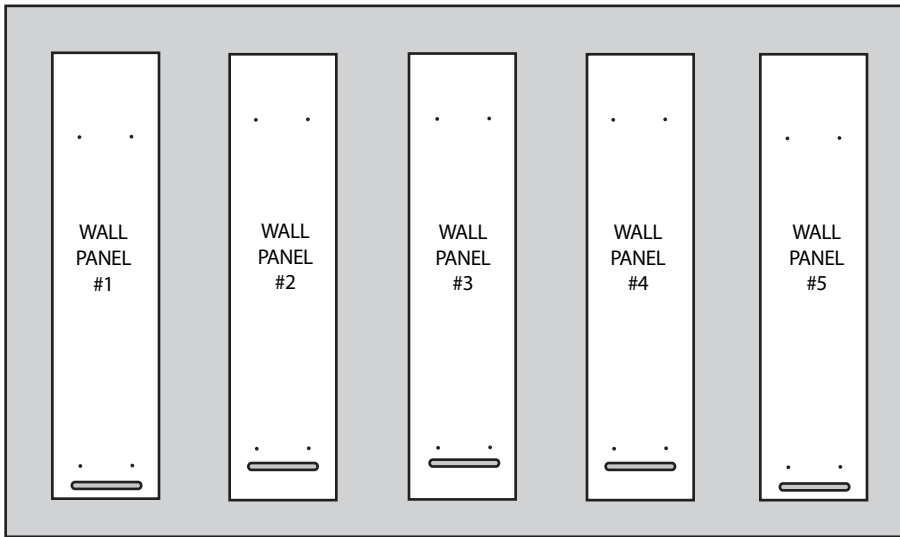

Figure 1A

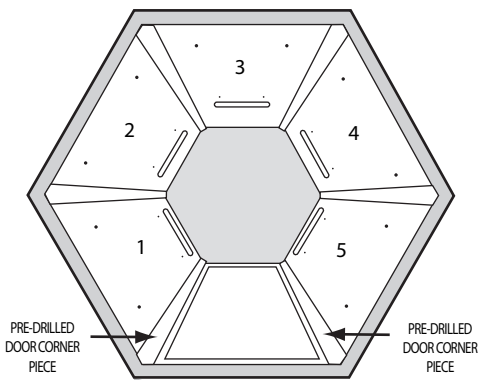

Figure 1B

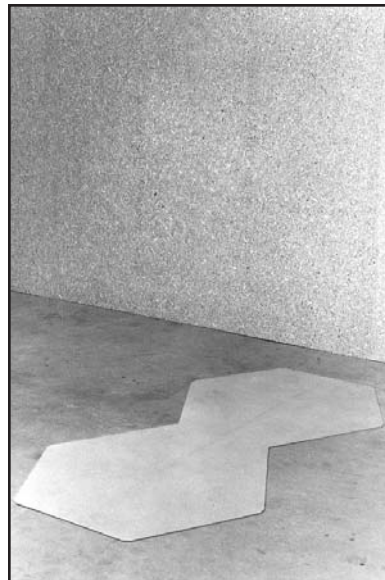

Figure 2

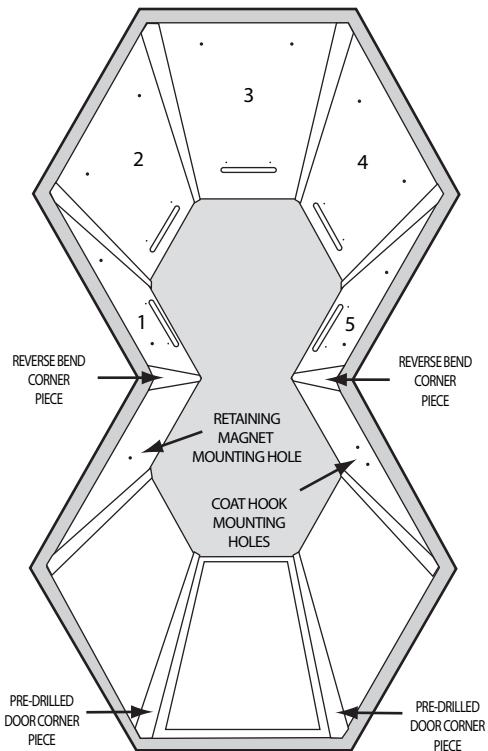

Figure 1C

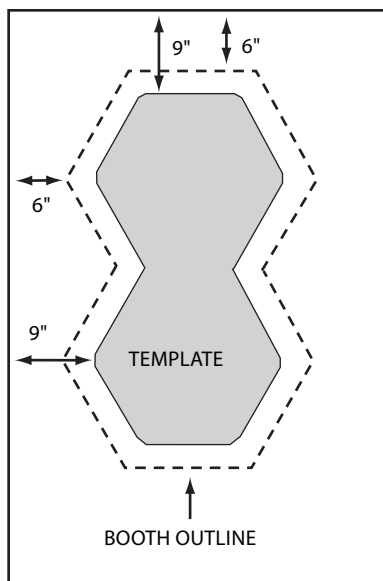

Figure 3



Figure 4



Figure 5

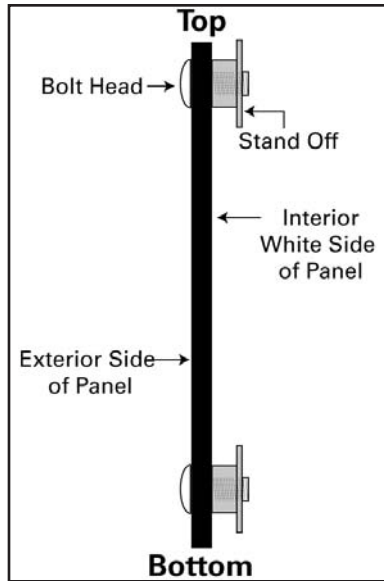

Figure 8

Attaching Wall Panel "Standoffs": The four vented wall panels have four pre-drilled mounting holes. Insert 1/4" mounting bolts (Hardware List Item C) through wall panel and secure with stand off (Hardware List Item B) as shown in Fig 7 & Fig 8. Make sure standoffs are installed on interior white side of panel.

REMINDER: On 160 Watt and 200 Watt units, there are 3 wall panels with a high vent port & 2 wall panels with a low vent port. Begin with a wall panel with a high vent port (Fig. 1A). This will achieve proper lamp fixture height when the unit is complete. On 220 Watt models, all ventilation ports are the same height.

Do this for all five vented panels.

SHELL ASSEMBLY: Begin with wall panel #3 (Figure 1A).

Note: Although the following procedure can be accomplished by one person, it is easier if one person "steadies" the wall panel while the other person handles the corner pieces.

REMEMBER: Pre-drilled corner pieces are used for door assembly.

With panel #3 in an upright position, start the corner piece a few inches from the bottom of the panel, and at a slight angle (Figure 6). Push corner piece all the way onto the panel, (Figure 7).

Attach next corner piece to other side of wall panel #3 using the above methods (Figure 8).

VERY IMPORTANT: Corner Pieces must be properly seated on wall panel. Using method shown in Figure 9 and 10, push corner pieces all the way onto the wall panel (Figure 11).

WORKING TIP: Before continuing, make sure corner piece assembly (corner piece and white corner piece trim) is even with the bottom of wall panel. Using a 2" x 4" block or similar, pull down on top of corner piece assembly (Figure 12).



Figure 6

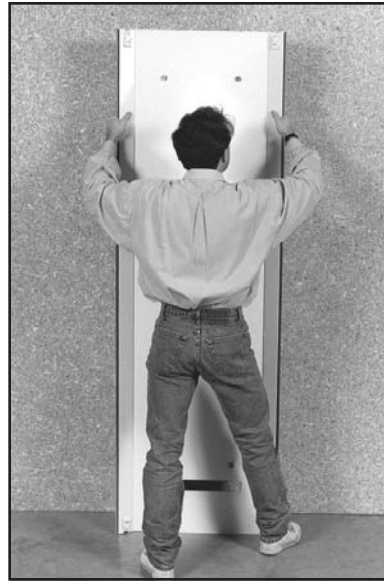

Figure 9



Figure 7



Figure 10

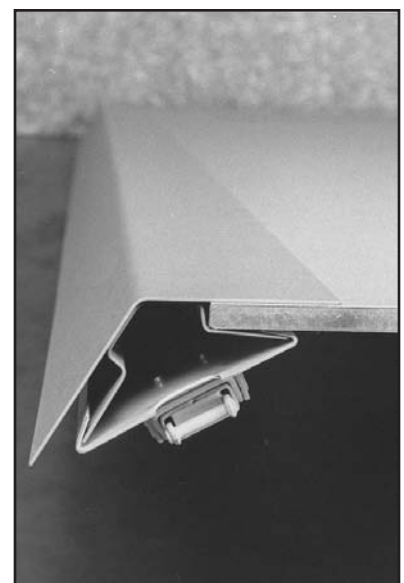

Figure 11



Figure 12

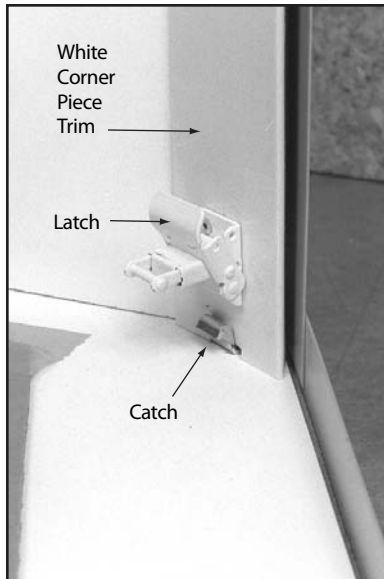

Figure 15

Raise both latches as shown in Figure 13 and set completed wall panel assembly in place (Figure 14).

Make sure white corner piece trim rests behind "catch" (Figure 15).

Hook latch over "catch" (Figure 16).

Close latch (Figure 17).

NOTE: Latch is spring loaded, use caution when opening or closing latch.

Assembly should stand on its own once it is latched into place. It is advisable that some-one "steadies" assembly until next panel is installed.

Insert wall panel #2 (Figure 1A) at an angle as shown in Figure 18.

Pull panel down and into corner piece (Figures 19 and 20).



Figure 13



Figure 16



Figure 18



Figure 14



Figure 17

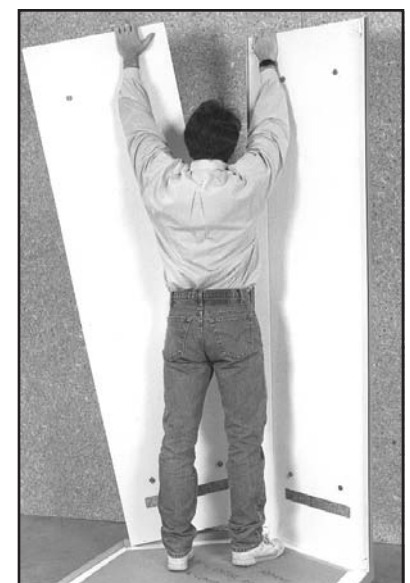

Figure 19

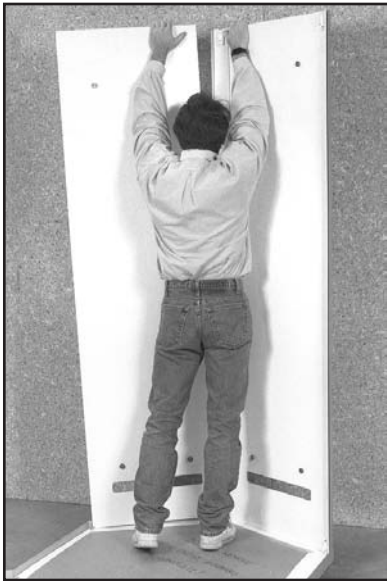

Figure 20

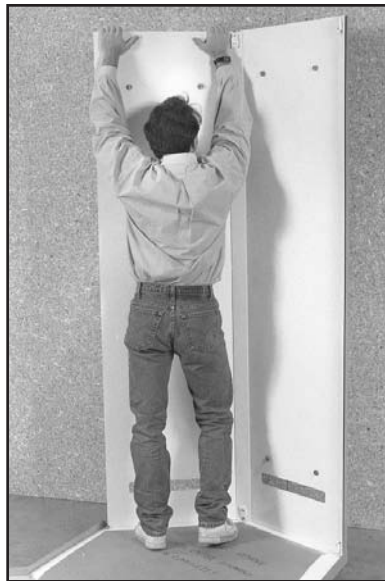

Figure 23



Figure 21



Figure 24



Figure 22



Figure 25

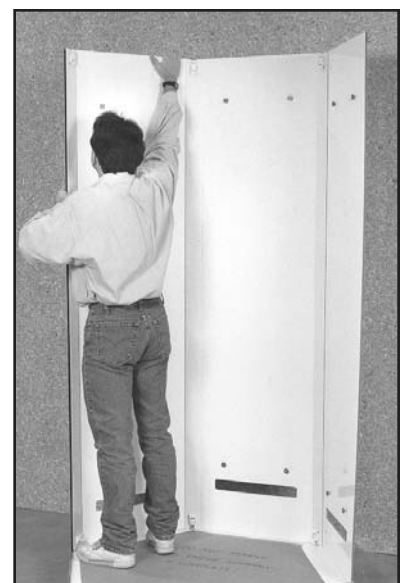

Figure 26

Finish by pushing wall panel completely into corner piece at both top and bottom (Figure 21 and 22).

Pull down on panel to make sure it is tight against the floor Figure 23.

NOTE: The above procedures must be repeated for each wall panel.

Install panel #4 (Figure 1A) using above techniques (Figure 24).

NOTE: Feel the top edge of corner piece to make sure wall panel is all the way into corner piece (Figure 11).

Install corner piece on wall panel #2. Make sure white corner piece trim rests behind "catch". Remember, starting the corner piece at an angle allows for corner piece to slide on easier (Figure 25). Push corner piece completely on to wall panel (Figure 26).

WORKING TIP: Raise latch on corner piece assembly to "up" position before installing.

Install corner piece on wall panel #4 using above procedures.

Install wall panel #1 (Figure 1A).

Install wall panel #5 (Figure 1A).

SUN CAPSULE I ONLY: Remember to use the two pre-drilled corner pieces previously set aside for the door assembly. Make sure pre-drilled holes are mounted as shown in Figure 31.

SUN CAPSULE II ONLY: Install inside corner piece assemblies (Figure 27) as shown in Figure 1C.



Figure 27

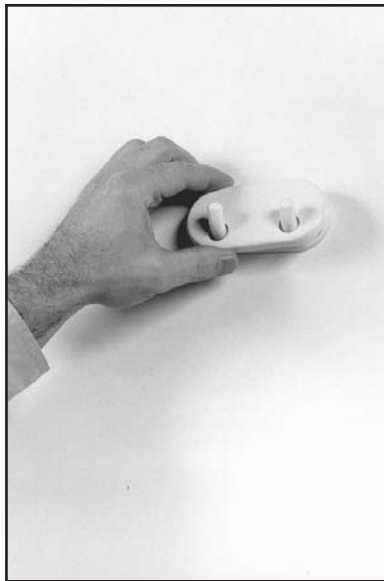

Figure 30

Attach retaining magnet and spacer to appropriate wall panel (Figure 1C) with acorn nut out (Figure 28). See Optional Hardware List Item B.

Install completed wall panel (Figure 29).

COAT HOOK: Fasten Coat Hook to wall panel as shown in Figure 30.

Install wall panel with coat hook in remaining inside slider.

Insert corner piece on both wall panels and secure bottom latches.

Install wall panel (with no holes) in corner piece adjacent to magnet (Figure 1C).

Install last wall panel (with no holes) in remaining slider (Figure 31).

Install two remaining corner pieces with pre-drilled holes for door assembly. Make sure pre-drilled holes are mounted as shown in Figure 31.

VERY IMPORTANT: Make sure that all wall panels are seated completely into corner pieces and are tight against the floor. Otherwise ceiling will be impossible to install.

Place all upper latches in open position before installing ceiling (Figure 32).

INSTALLING THE CEILING:

CAUTION: The ceiling for a Sun Capsule I can be managed by one tall person. A Sun Capsule II must be handled by two persons, otherwise injury to the person and/or damage to the ceiling may result.

WORKING TIP: It is recommended that persons 5"9" or taller attempt the following procedure, unless shorter people are equipped with platform shoes.



Figure 28

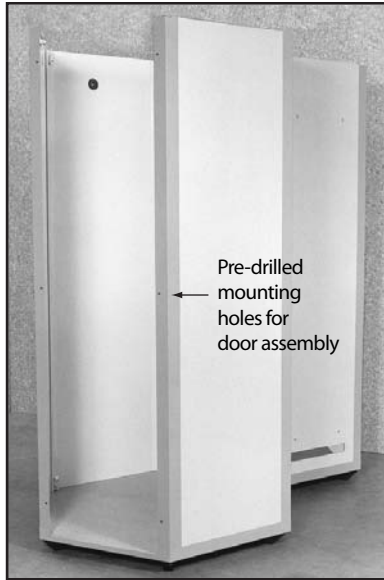

Figure 31



Figure 29



Figure 31A



Figure 32



Figure 33

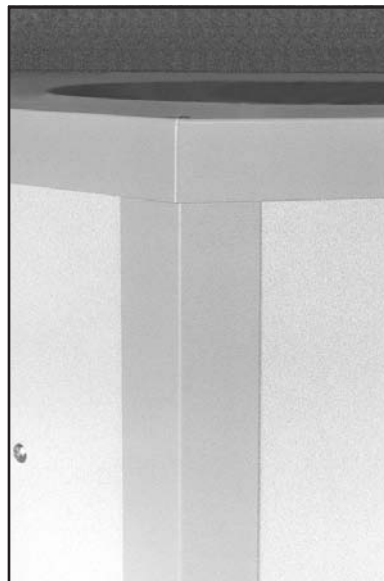

Figure 36

Set the ceiling in place, making sure that all of the wall panels and corner pieces fall within the ceiling trim (Figure 33).

**CAUTION:** Be careful not to scratch the ceiling.

**WORKING TIP:** Start by making sure the wall panel and corner pieces at the back of the booth fall within the ceiling trim first. Then work your way around to the front.

**VERY IMPORTANT:** Make sure the white corner piece trim falls behind ceiling catches. (Figure 34). In some cases ceiling catch may go behind the corner piece trim, causing trim to bow out. It will be necessary to push trim in so that catch falls in front of trim.

It may be necessary to pull down on outside corners to seat ceiling on wall panels. (Figure 35).

If the apex of the corner piece does not line up with the apex of the ceiling trim, (Figure 36) strike corner piece gently with the palm of your hand (Figure 37). If necessary, do this to each corner before you attempt to secure the latches.

**WORKING TIP:** If your Sun Capsule is being assembled on an uneven floor, you may have gaps between the Sun Capsule floor and the wall panel or the ceiling and the wall panel. This may make it difficult to secure the top latches. By placing a 2" x 4" block under the problem corner and pulling down on that corner from the outside, the gap should disappear. If not, a gentle rocking of the shell should get the ceiling to settle down on the wall panel (see Figure 38).

Secure top latches (Figure 38).

**WORKING TIP:** It may be necessary to apply a "quick burst of pressure" to the latch to get it in place over the catch. It may help to have someone pull down on the outside corner during procedure (Figure 35).

**INSTALLING THE INSIDE FAN GUARD:** It is necessary to have two people for this procedure: one person to hold the fan guard in place, lining up the four mounting holes, and the other to secure the fan guard in place with supplied hardware (Hardware List Item E). Be sure to tighten hardware securely but **do not over tighten.** (Figure 39).



Figure 34



Figure 37

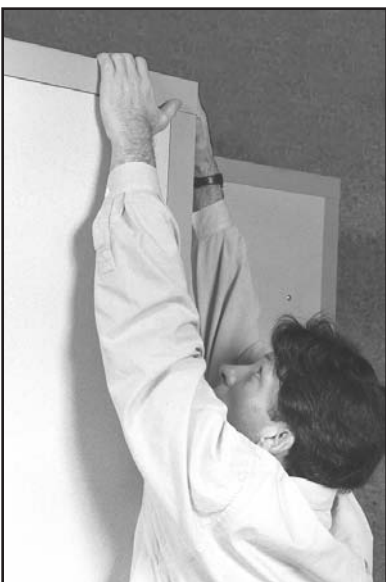

Figure 35

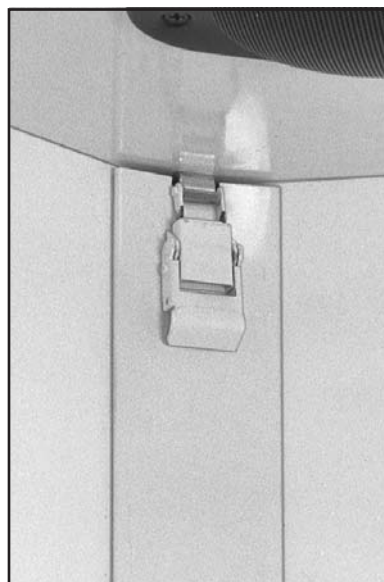

Figure 38



Figure 39



FIG 35



FIG 38

**LAMP FIXTURE INSTALLATION:**

**IMPORTANT:** The inside fan guard must be in place before installing lamp fixtures.

All lamp fixtures are numbered at top of fixture. **CAUTION:** When installing lamp fixture(s) do not allow lamp fixture to scratch Linoleum floor or ceiling (Fig 35).

Position lamp fixture #5 by carefully leaning the fixture up against wall panel #5. (Fig 1) Feed the junction box assembly up through junction box hole in ceiling (Fig 36).

Remove protective film from fixture #5 dress plate. Install dress plate with appropriate screws from Hardware List Item D. (Fig 37)

Install lamp fixture #5 by centering the #5 lamp fixture on the wall panel. Feel behind the fixture to locate the relationship between the "stand offs" on wall and the "tear drops" in lamp fixture. Reach down, bending at the knees, and lift the fixture up until you feel the top "tear drops" fall behind the stand offs.

**Caution: Lift fixtures at heavy gauge, double support lamp guard wires only.** (Figure 38)

Before lowering the fixture, push the bottom of the fixture against the wall panel and lower the fixture so that bottom "tear drops" fall behind bottom "Stand Offs."

**IMPORTANT:** Be sure to catch all 4 stand offs.

Install fixture #5 dress plate bushing (Fig 39).

Rest lamp fixture labeled #4 against the #4 wall panel (Fig 1 for reference).

**Plug in power cord(s) before mounting lamp fixture(s) (Fig 40). Install lamp fixture #4 repeating above procedures.**

Install lamp fixtures #3, #2 & #1 repeating above procedures.

If you have a 220Watt Sun Capsule II proceed to page 22

If you have a 160/200Watt Sun Capsule II proceed to page 23

If you have a 160/200/220Watt Sun Capsule I proceed to page 24

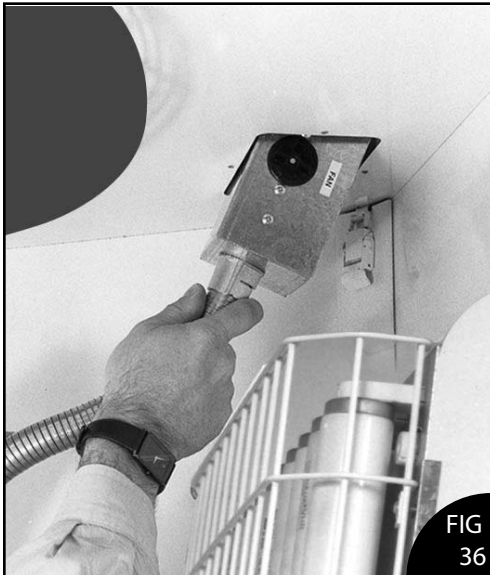

FIG 36

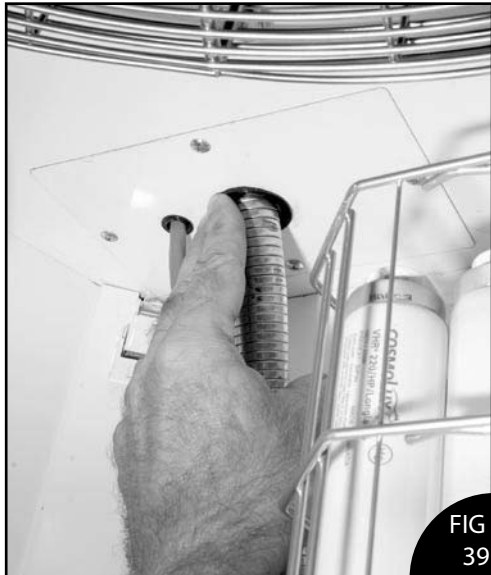

FIG 39



FIG 37



FIG 40



FIG 41



FIG 44

**INSTALLING #6 LAMP FIXTURE:  
220WATT SUN CAPSULE II ONLY**

NOTE: The following instructions should be completed by two people.

Remove screws from ceiling and floor.(Fig41)

Insert hinge pin into top hinge leaf on lamp fixture (Fig 42)

Lift lamp fixture into dressing room portion of unit. Use the heavy double support wires to lift fixture.

While one person holds the lamp fixture steady, the other person tilts the lamp fixture back far enough to insert hinge pin with collar into lower hinge leaf. (Fig 43)

Move fixture assembly into position and attach top hinge pin to ceiling using previously removed screws. (Fig 44)

CAUTION: Do Not OverTighten

Align bottom hinge pin with pre-drilled holes & attach bottom pin to floor using previously removed screws. (Fig 45)

Plug fixture #6 into fixture #1.

Install 4 white plugs into exposed teardrop openings in the back of #6 lamp fixture. Fig 46 and Hardware list item Q

PROCEED TO PAGE 24



FIG 42



FIG 45



FIG 43



FIG 46





FIG 47

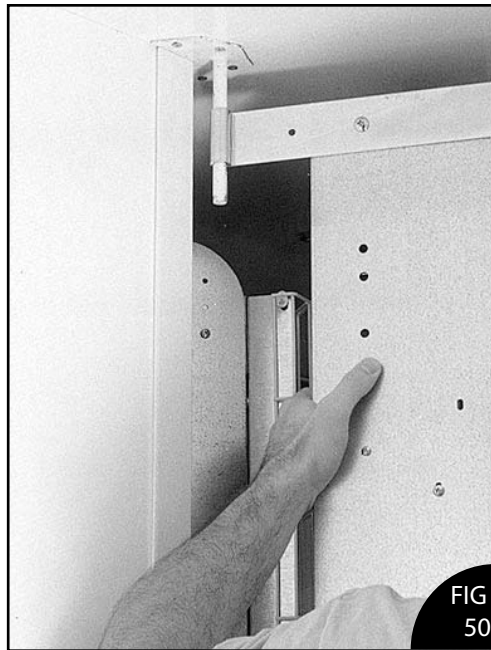

FIG 50

160 & 200WATT SUN CAPSULE II ONLY  
Remove screws from ceiling & floor (Fig 47).

Install top & bottom hinge pins. Do not overtighten (Fig 48 & 49). Make sure sleeve is installed on bottom hinge pin. (Fig 49).

Lift & position fixture #6 so that top hinge leaf slides onto top hinge pin (Fig 50).

Raise fixture so that bottom hinge leaf is directly above bottom hinge pin. Gently lower panel down to sleeve on bottom hinge pin (Fig 51).

Plug fixture #6 into fixture #1.

Install 4 white plugs into exposed teardrop openings in the back of #6 lamp fixture. (Hardware list item Q)

STOP PIN INSTALLATION:  
Install the stop pin as shown in Fig 53.

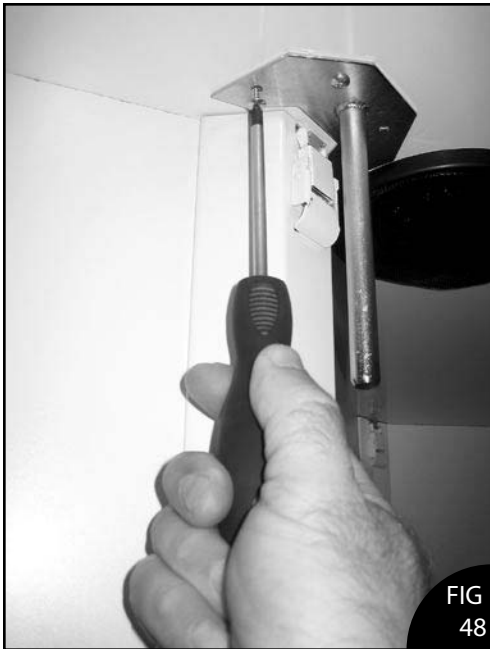

FIG 48



FIG 51

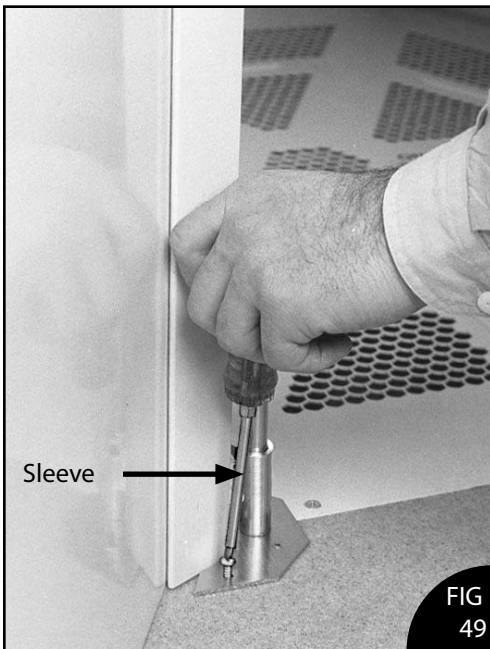

FIG 49



FIG 52

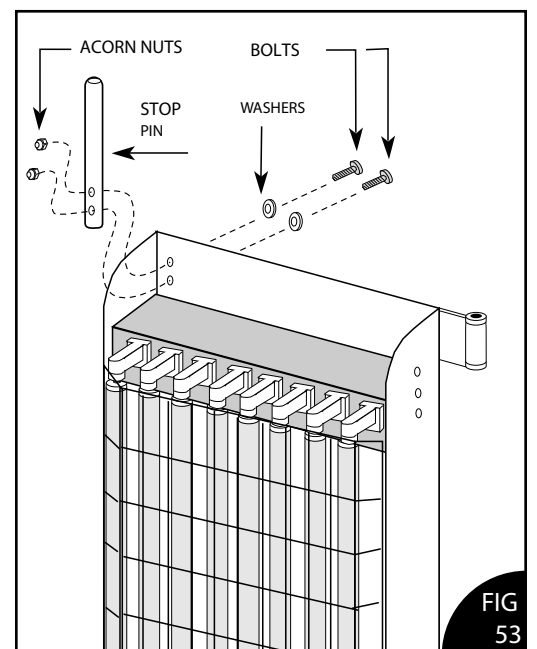

FIG 53



FIG 54

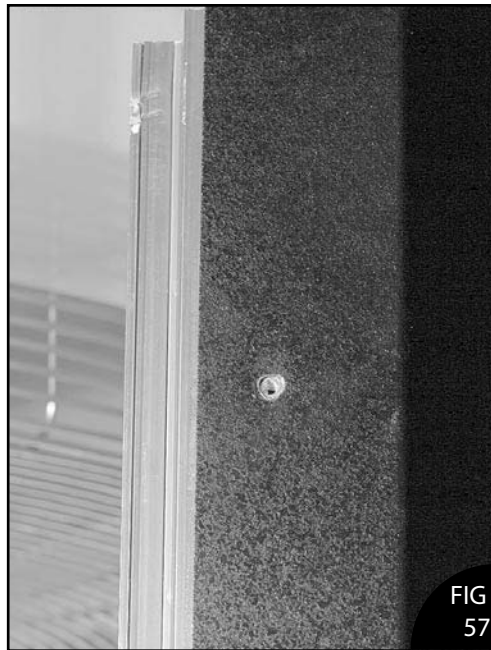

FIG 57

**THRESHOLD INSTALLATION:** Position threshold as shown in Fig 54. Secure with two 10-32 x 3/4" machine screws and lock nuts (outer holes) and one wood screw (center hole). (Hardware List Item F)

**DOOR ASSEMBLY INSTALLATION:**

**NOTE:** All Sun Capsule I models must be mounted with hinge on left side. Sun Capsule II models are mounted according to decorative package.

Begin by inserting the door hinge assembly into the door corner piece groove (Fig 55). Pre-drilled pilot holes in the hinge assembly should line up with the pre-drilled holes in the corner piece when hinge is completely inserted into the corner piece. It may be necessary to lift the door assembly slightly to align the holes. Use appropriate screws (Hardware List Item D) to secure the hinge assembly to the corner piece.



FIG 55



FIG 58

**DOOR STRIKER INSTALLATION:**

Insert the door striker in the remaining corner piece groove. Make sure striker is pushed down to the floor and magnet strip is facing out. Line up the pre-drilled pilot holes in the striker with the pre-drilled holes in the corner piece and secure with appropriate screws. (Fig 56 & 57) (Hardware List Item D)

**DOOR ADJUSTMENT:**

There is enough play in the corner piece holes to shift the door striker slightly to the left or right. For proper door closure, you should have approximately 1/8" gap between door and striker when door is in the closed position (Fig 58). Mating surfaces of the magnetic strips should line up and a solid feel should be obtained on door closure.

**INSIDE DOOR HANDLE INSTALLATION:**

**FOR SUN CAPSULE II ONLY :** Install the inside door handle as seen in Fig 59 & 60 (Hardware List Item M).



FIG 56



FIG 59



FIG 60



FIG 61



FIG 64

### SUN CAPSULE I ONLY

#### INSTALLING #6 LAMP FIXTURE:

While one person steadies the door, the other person hangs the #6 lamp fixture on the door. (Fig 61). Use the heavy double support wires to lift fixture.

**IMPORTANT:** Make sure you catch all four stand-offs

Plug fixture #6 into fixture #1.

#### INSTALLING GRAB BARTO #6 LAMP

**FIXTURE (ALL MODELS):** Removal of the lamp guard is required since the hardware will be installed through the back of the guard (Fig 62). Using appropriate hardware (Hardware List Item L) attach bar to lamp guard above the heavy double horizontal wire located just above waist high. The bar will rest on this wire (Figure 63).

**NOTE:** Make sure the heads of the bolts are on the back of the guard with decorative acorn nuts on the front.

Re-install lamp guard. Fig 64

#### FAN "SHUT OFF" SWITCH:

The Fan "Shut Off" Switch (Hardware List Item G) allows for easier entrance and exit by shutting off the fan when the door is open. Feed fan shut off switch cord through hole in ceiling Fig 65. Remove the 4 screws in the ceiling and use them to install the fan shut off switch. Make sure plastic plunger is facing in the proper direction See Fig 66. Refer to figure 67 if you have a 220 Watt Sun Capsule I. Place "Fan Shutoff Cord" under retaining clip already in place on the top of the ceiling. Make sure cord is clear of upper fan guard.



FIG 62



FIG 65



FIG 63



FIG 66

#### Fan Switch Placement for 220Watt SC I



FIG 67

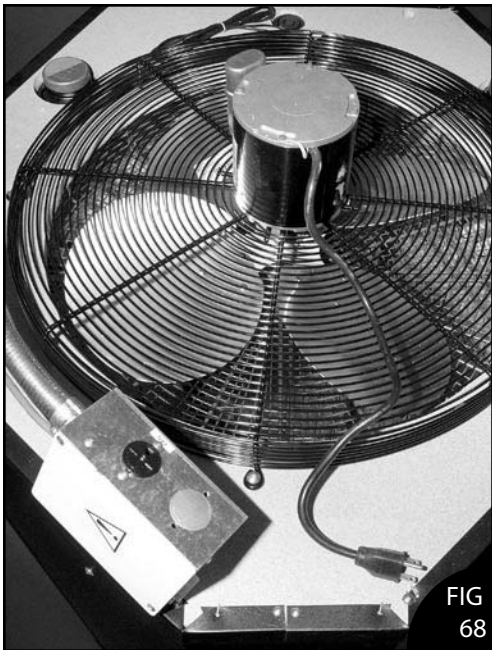

FIG 68

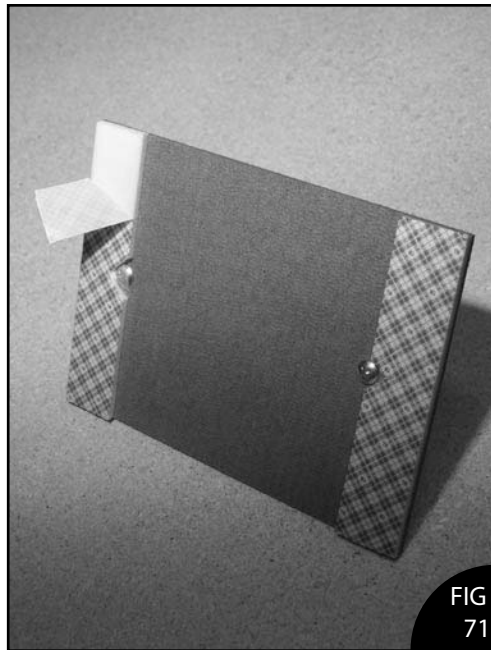

FIG 71

**FAN INSTALLATION:** To avoid damage to fan blade, carefully place the upper fan assembly into hole on top of ceiling. Line up the pilot holes in ceiling with mounting holes in upper fan assembly, making sure power cord will be able to reach the junction box shown in Figure 68. Fasten upper fan assembly to ceiling with appropriate screws making sure not to strip out holes in ceiling by overtightening screws. (Fig 69)

**INSTALLATION OF OVERHEAD LIGHT:** Feed lead wires of overhead light through hole in ceiling. Press light firmly into hole. (Fig 70)

**MOUNTING THE JUNCTION BOX**  
Locate junction box mounting bracket. Peel off protective tape (Fig 71) and mount to junction box as shown in Fig 72. **BE SURE BRACKET IS ORIENTATED EXACTLY AS SHOWN IN THE FIG. 72**

Locate pre-drilled holes on the top rear of the ceiling and mount junction box to ceiling using supplied screws Fig 73.

**CAUTION:** Do not overtighten screws.

Plug fan shut off switch cord into appropriate receptacle. Fig 74

Plug fan power plug into into appropriate receptacle.

Plug overhead light into appropriate receptacle.

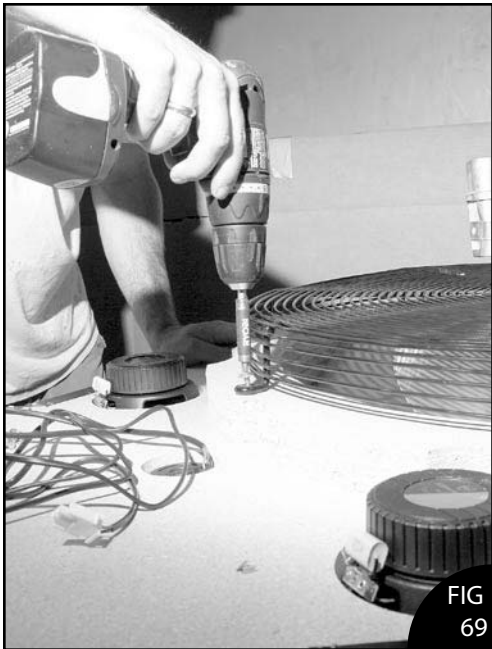

FIG 69



FIG 72



FIG 70

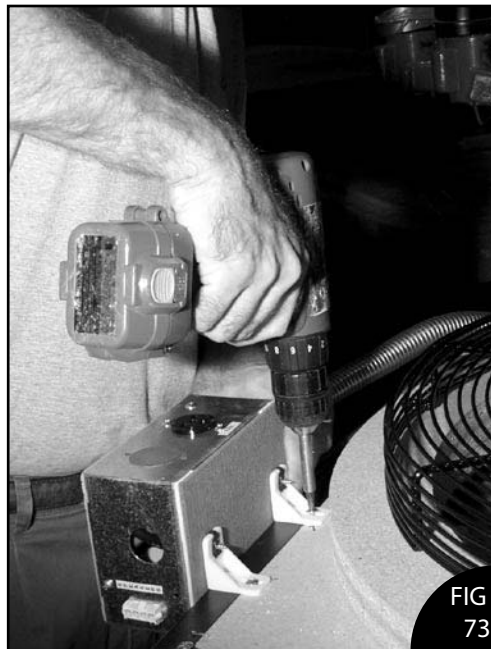

FIG 73



FIG 74

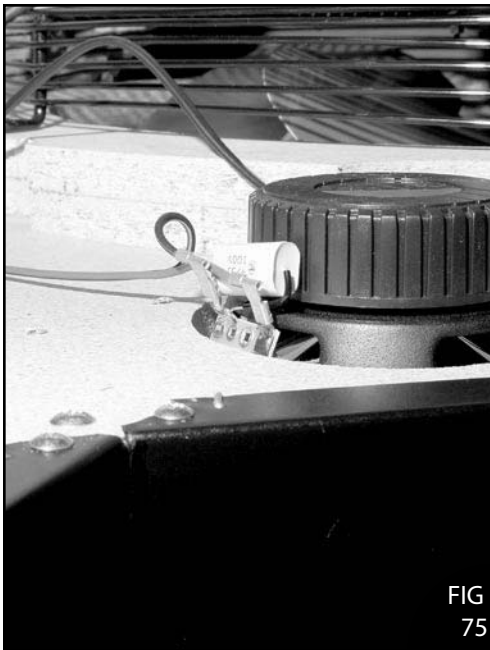

FIG 75

**SPEAKER CONNECTION**

In the hardware kit, locate the white four prong male plug with four wires coming out of it. Two of these wires are positive (red) and two of these wires are negative (black).

Connect one of the positive (red) wires to the positive terminal on the right speaker, marked with a red indication. Connect one of the negative (black) wires to the negative terminal on the right speaker. (Fig 75)

Repeat above procedure for left speaker.

Plug the white 4 prong male plug into the corresponding white four prong female receptacle on the side of the junction box labeled "Speakers"

**ATTENTION: BE SURE TO CONNECT THE POSITIVE WIRES TO THE POSITIVE TERMINALS AND THE NEGATIVE WIRES TO THE NEGATIVE TERMINALS OR SPEAKERS / HEADPHONES WILL NOT FUNCTION PROPERLY.**

**STEREO CONNECTION**

The stereo wires are not provided with the Sun Capsule.

Four stereo wires are going to be needed to complete this procedure.

Locate the four-clip terminal on the front of the junction box labeled Stereo. -THE TOP ROW OF TERMINALS IS WHERE FOUR STEREO CONNECTIONS ARE GOING TO BE MADE.

**RIGHT CHANNEL CONNECTION:**

The junction box terminal has a positive (red) connection for connecting to the right channel of your stereo receiver. The junction box terminal has a negative (black) connection for connecting to the right channel of your stereo receiver.

**LEFT CHANNEL CONNECTION:**

The junction box terminal has a positive (red) connection for connecting to the left channel of your stereo receiver. The junction box terminal has a negative (black) connection for connecting to the left channel of your stereo receiver.

**BE SURE TO CONNECT THE POSITIVE CONNECTIONS TO THE POSITIVE TERMINALS AND THE NEGATIVE CONNECTIONS TO THE NEGATIVE TERMINALS OR STEREO SPEAKERS / HEADPHONES WILL NOT FUNCTION PROPERLY.**

**NOTE:** The bottom row of terminals are only used if the stereo system is being daisy chained to another unit.

**REMOTE TIMER:** Plug the remote timer into the junction box. Timer works on a 12 volt system. The plug can be inserted only one way. Do not force.



FIG 76

**FINAL ADJUSTMENTS:** If your floor beneath the Sun Capsule is not level, the door will not be parallel to the ceiling framework. If this condition exists, the booth will need to be shimmed. When looking at the front of the booth, if the gap between the top of the front door frame and the ceiling trim is bigger on the right, then typically a shim will be necessary under the bottom left corner of the door frame (Fig 76) & vice versa. Do this by lifting the appropriate corner and slide a shim (supplied) or something similar under the 2" x 3" support at that corner. You may have to experiment until you get it perfect. (Fig 77)

**PROTECTIVE CARDBOARD** : Remove the cardboard that protects the Fast Flow Floor. Although this floor is quite durable, it is not scratchproof. Take care not to walk on surface with street shoes.

**ELECTRICAL HOOK UP:**

Your Sun Capsule must be connected to power by a licensed electrician in accordance with the National & Local Electrical Codes.

We recommend using name brand circuit breakers at your electrical panel. They are heavy duty and eliminate nuisance tripping.



FIG 77

### **IMPORTANT**

A RUNNING VOLTAGE BETWEEN 230 TO 235 VOLTS MUST BE ACHIEVED TO OBTAIN PEAK PERFORMANCE.

Please factor in the load of other equipment and air conditioning running in the salon at the same time.

If the voltage is higher or lower than this range YOU MUST USE A BUCK BOOST TRANSFORMER TO DELIVER THE PROPER VOLTAGE.

In the event a buck boost transformer is used it should be mounted as close to the service panel as possible. NOTE: A buck boost transformer will add 6 to 9 amps to the overall load at the service panel. In cases where incoming voltage readings are very low, two buck boost transformers wired in series may be necessary.

### **VERY IMPORTANT**

There is NO NEUTRAL in any 60 Hz Sun Capsule VHR System!!!

\*50 Hz systems must operate between 220 volts and 225 volts.

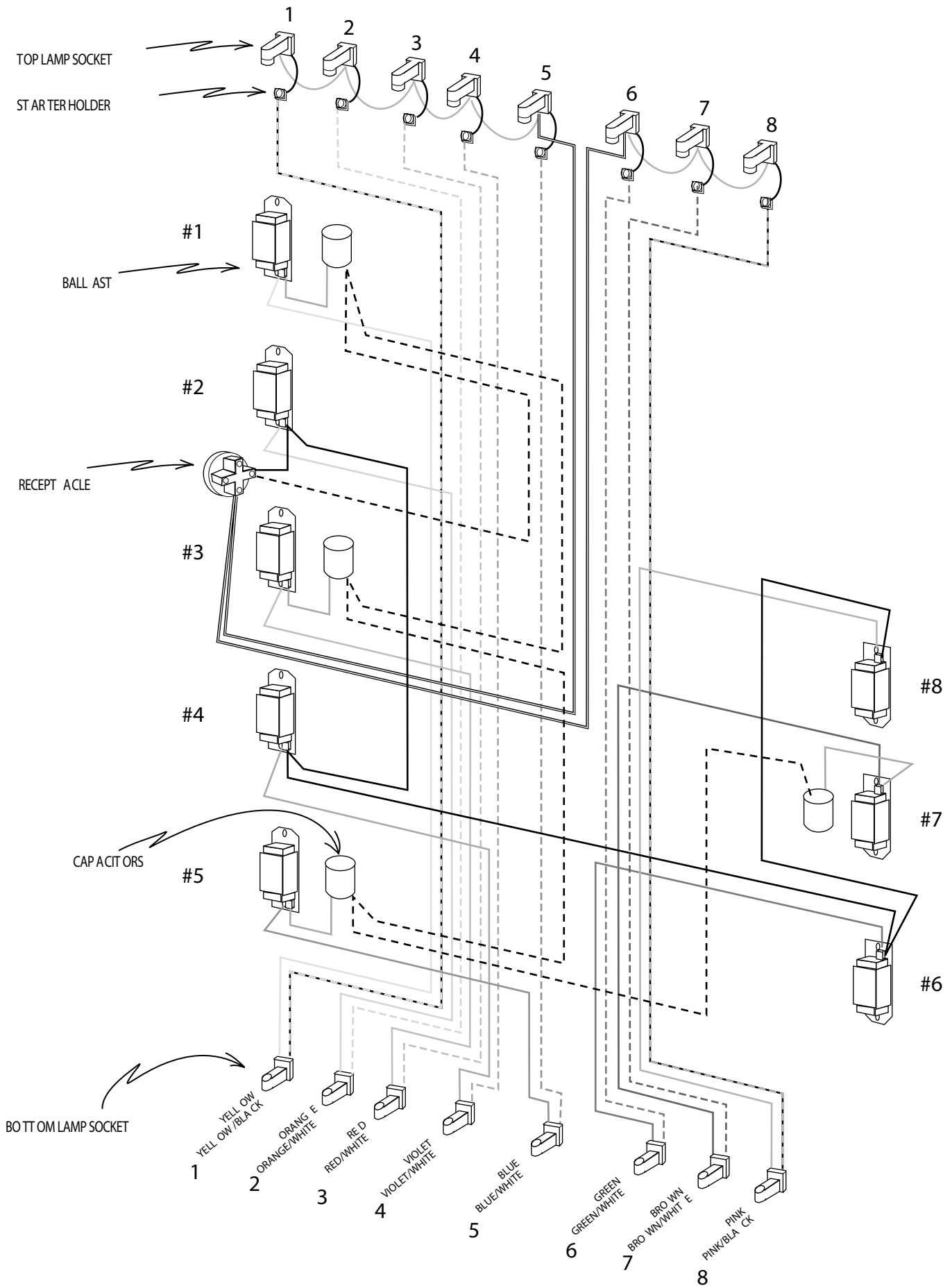

8 LAMP FIXTURE WIRING

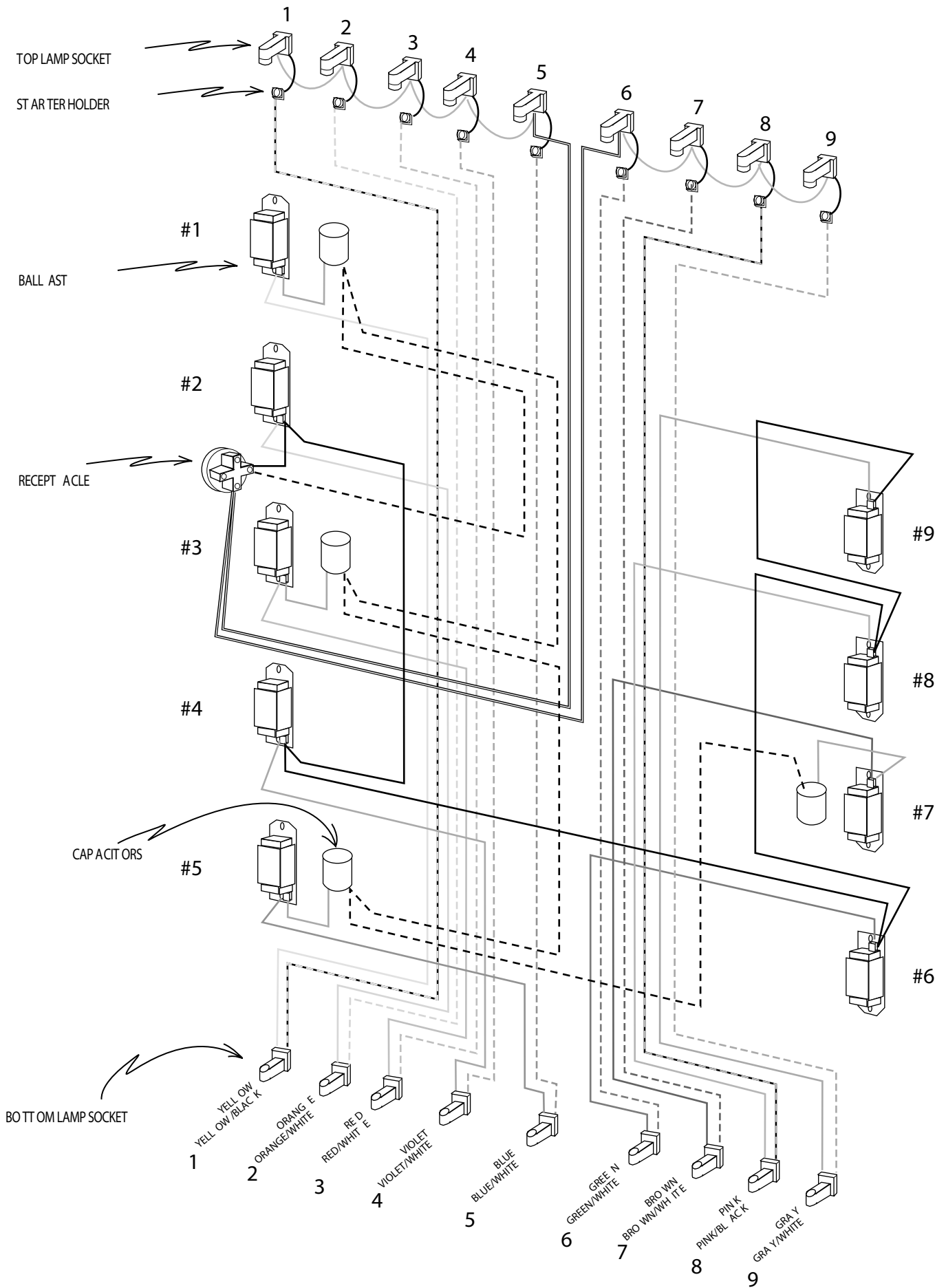

9 LAMP FIXTURE WIRING



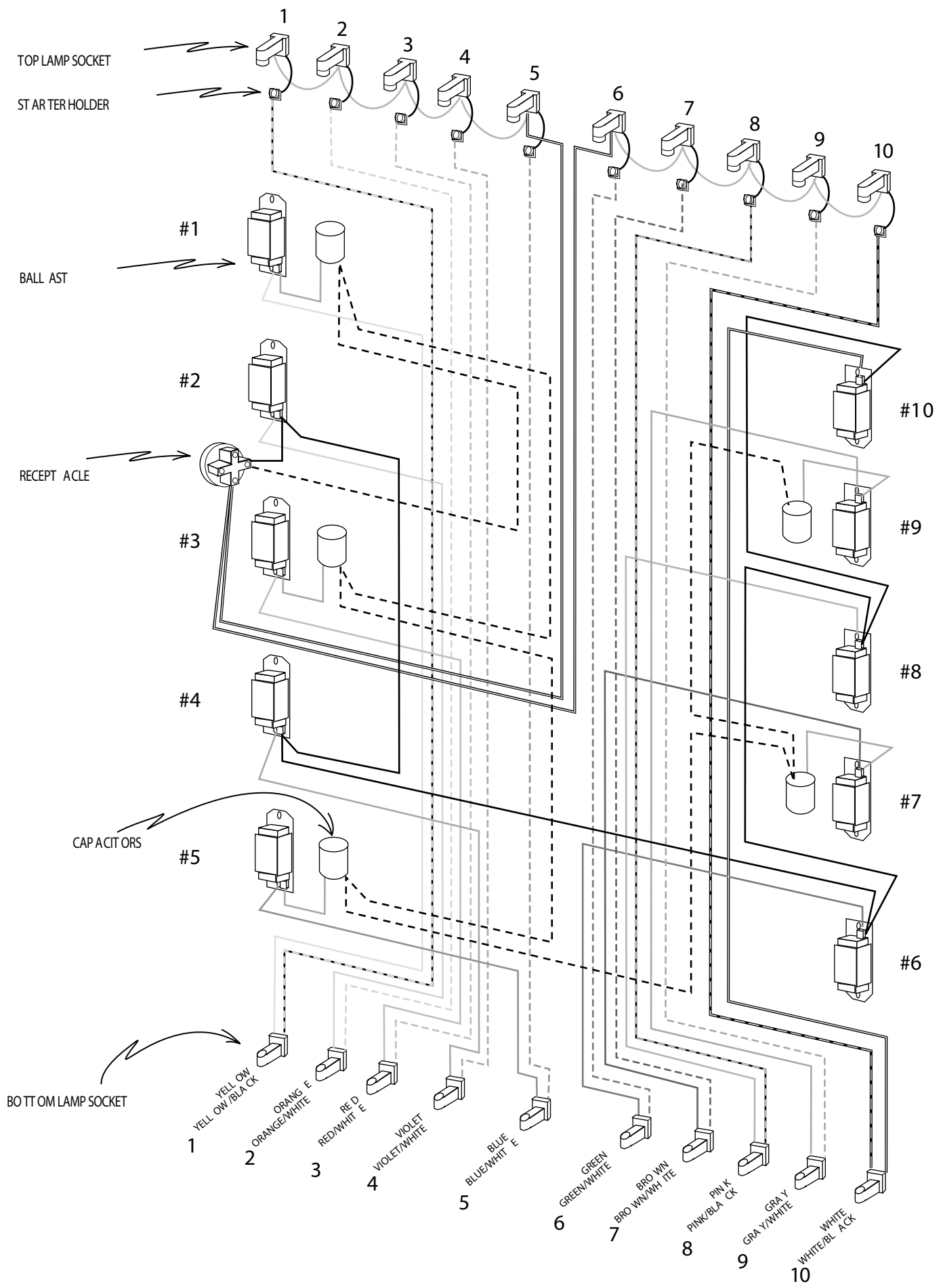

10 LAMP FIXTURE WIRING

JUNCTION BOX

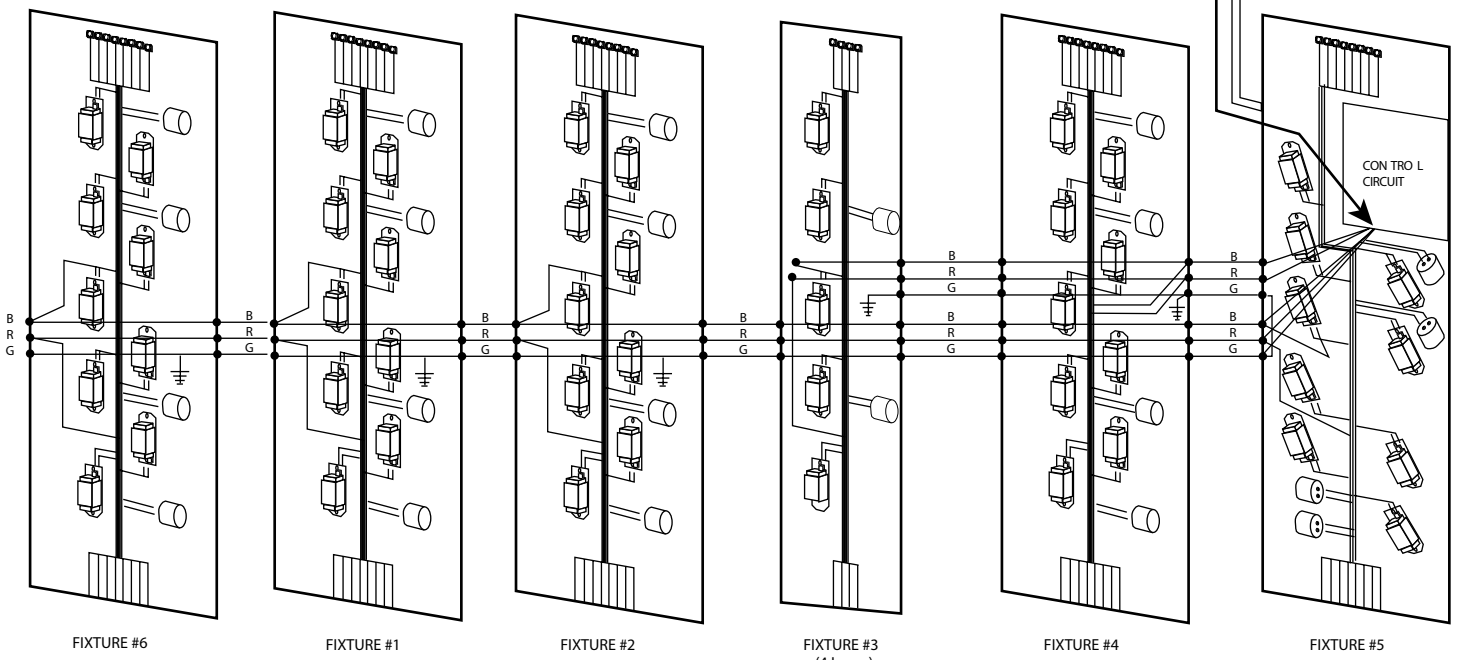
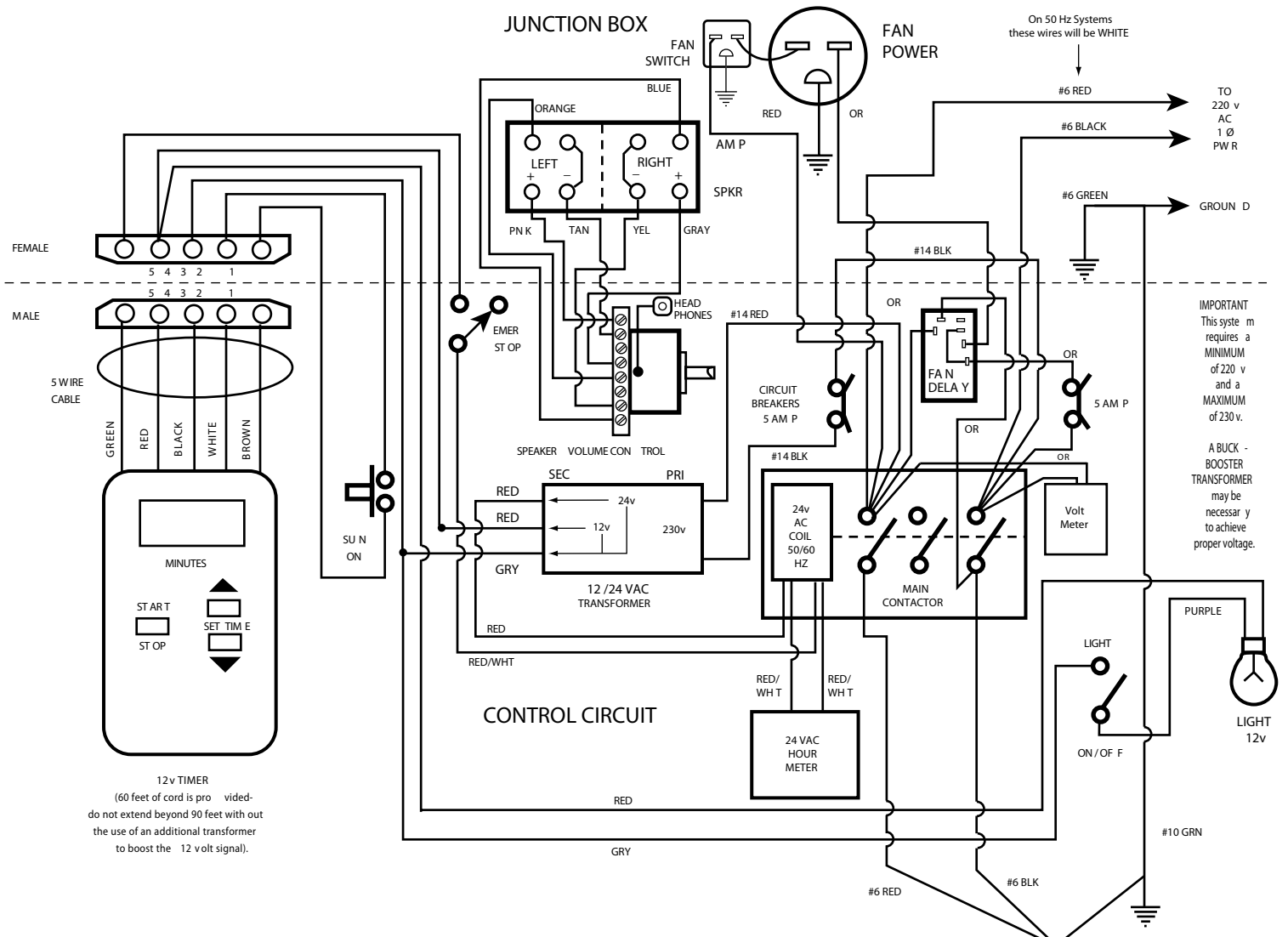

SINGLE PHASE SYSTEM SCHEMATIC

### JUNCTION BOX

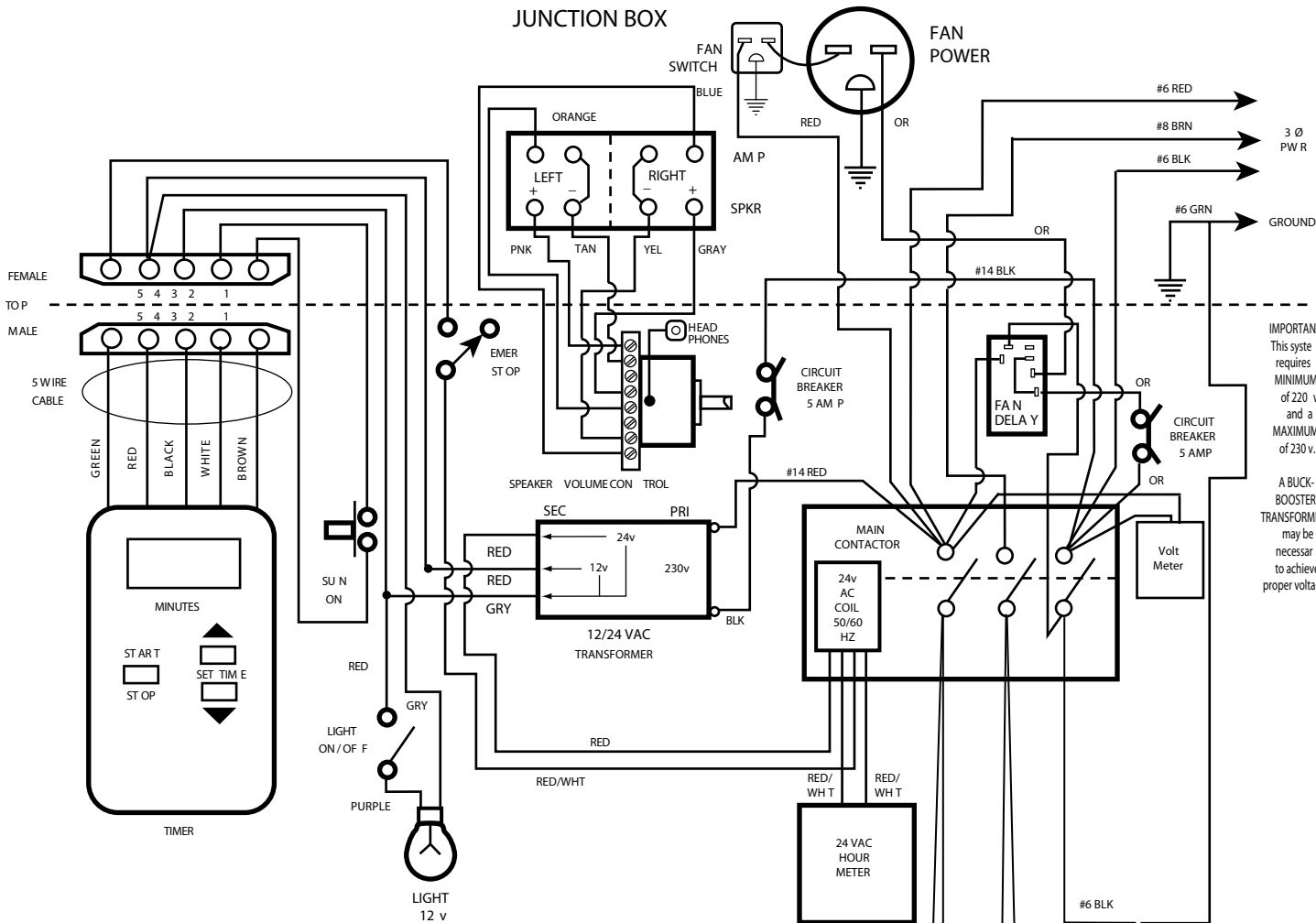

**IMPORTANT**  
This system requires a MINIMUM of 220 v and a MAXIMUM of 230v.  
  
A BUCK-BOOSTER TRANSFORMER may be necessary to achieve proper voltage.

### CONTROL CIRCUIT

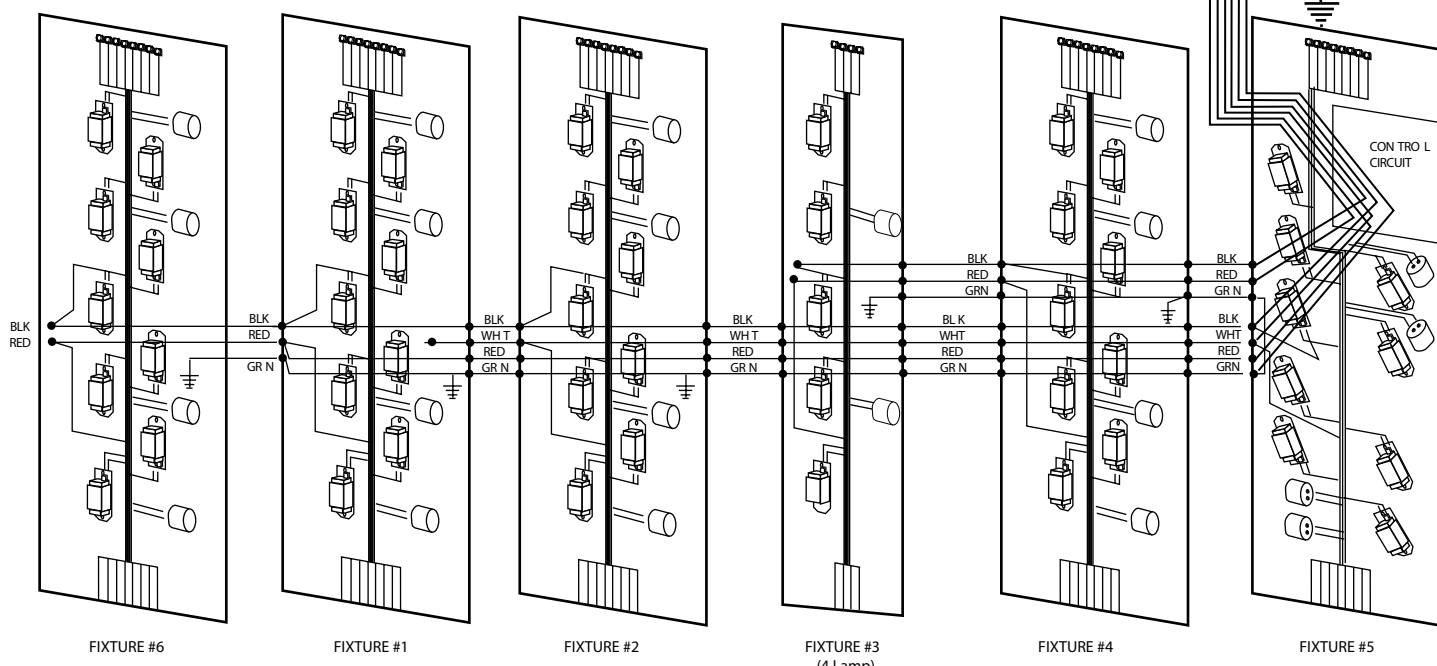

60 HZ 3/1 PHASE SYSTEM SCHEMATIC

# General Trouble Shooting Guide

## Tanning Unit Will Not Start:

1. Make sure the “Emergency Stop” switch on the control panel is in the “ON” position.(located on first lamp panel on the right when walking into the unit).
2. Make sure the voltmeter on the control panel indicates at least 230 volts.
3. If there is no voltage indication on the voltmeter, check your electrical service panel to verify the circuit breaker is in the “On” position. Turn circuit breaker to ‘off’ position and then place circuit breaker in ‘on’ position.
4. Isolation test: Unplug the timer cable from the junction box on top of the booth . Bend a bare metal paper clip, into a “U” shape. Insert one end into the first hole and the other end into the third hole (counting down from the top) of the “Remote Timer” receptacle on the junction box. If the booth starts with the paper clip in place, either the timer or timer cord is faulty. If the booth does not start, then the problem lies within the unit.

At this point call Sun Capsule Service at (978) 532-7517

## One Lamp Will Not Start:

1. Replace the lamp in question with a lamp that works.
2. Replace the starter for the lamp in question with one that works.
3. Inspect top and bottom socket for cracks or other visible damage

**THE PROCEEDING STEPS SHOULD BE PERFORMED BY A QUALIFIED SERVICE TECHNICIAN ONLY!**

**CAUTION: When trouble shooting components inside the lamp fixture, shut the power off at the circuit breaker.**

REMOVE LAMP GUARD, LAMPS & LAMP FIXTURE COVER TO PERFORM THE FOLLOWING PROCEDURES:

4. Check the wires going to the top and bottom lamp sockets to ensure that they are firmly installed in the socket(s). Confirm this with a gentle tug on each wire at the socket. There should be a colored wire with a black or white stripe going to the starter holder of each top socket as well as a white ‘jumper’ wire connecting each top socket to the next top socket. Make sure wires are firmly inserted in top and bottom sockets. See wiring diagram in Sun Capsule Owners manual for further illustration.
5. Check the wires going to the ballast for the lamp in question. See wiring diagram in Owners manual. Make sure that wires are firmly inserted beneath screw terminals on ballast in question.

THINGS TO LOOK FOR:

Burnt or discolored wires at ballast terminal

Loose or broken wires

6. If it is odd numbered lamp (counting from left to right) that will not start, you need to check the capacitor for the lamp that won’t start.

**CAUTION: You must discharge the capacitor(s) before you touch or try to remove them. Place a screwdriver across the terminal posts of the capacitor. A loud ‘pop’ may occur, this is normal. Now the capacitor is safe to handle.**

The easiest way to verify a faulty capacitor is to replace the capacitor in question with one that works.

## **One or more Lamp Fixtures will not light:**

A series of power cords with plugs carry the power from one lamp fixture to the next. It is important to check that all plugs are properly inserted into each fixture. NOTE: On some models, the number 3 and 4 lamp fixture has two cord sets. Make sure both cord sets are properly inserted.

## **Unit Does Not Come On At Times or Shuts Off During A Session:**

1. If the timer cord has been lengthened beyond 90' in total length, a transformer may be necessary to boost the low voltage signal to the timer. To test this situation, unplug the timer from the end of the cord and plug the timer directly into the "Remote Timer" terminal on the junction box on top of the unit. This will bypass the cord between the timer and the booth. If the booth runs flawlessly with the timer plugged directly to the unit, the problem is with the cord.
2. If the timer cord has been cut and spliced back together to allow the cord to be installed through ceilings and walls to get to your front desk, check the connections for proper termination. To test this, unplug the timer from the end of the cord and plug the timer directly into the "Remote Timer" receptacle on the junction box on top of the booth. This will bypass the cord between the timer and the booth. If the booth runs flawlessly with the timer plugged directly to the booth, the problem is with the cord.
3. If a timer system other than the Sun Capsule digital timer is being used, disconnect the alternate timer and test with the Sun Capsule timer to determine if the foreign timer system is faulty. If the unit operates properly with the Sun Capsule timer in place, contact the manufacturer of the alternate timer for assistance.

## **Trouble Shooting Your Timer:**

1. If you are using your Sun Capsule timer as a stand alone timer, the timer functions and operations are very basic. Should you somehow enter into the programming modes of the timer (the digital display begins to flash a series of random numbers) you can reset the timer in two ways: First, simply press the "Start/Stop" button and the timer should return to normal. Or, unplug the timer from the Sun Capsule and plug it back in. After you plug the timer back in, it will go through a series of random numbers, then reset back to zero.
2. Test for a faulty timer. Unplug the timer from the junction box on top of the booth. Using a bare metal paper clip bent into a "U" shape, insert one end into the first hole and the other end into the third hole (counting down from the top) of the "Remote Timer" receptacle on the junction box. If the booth comes on with the paper clip in place, either the timer or timer cord is faulty. If the booth does not come on the problem lies within the unit.
3. If using your Sun Capsule timer with a database system, the database will completely override the stand-alone functions of the timer. To disconnect the timer from the database, unplug the CAT-5 cables going into it. Then unplug the timer from the "Remote Timer" receptacle on the junction box and **plug it back in**. This will clear the timer from thinking it is still connected to the database. At this time you should be able to manually set time on the timer and start the tanning session.
4. If using your Sun Capsule timer with a database system, press the "Set Time" button on the timer. When hooked up properly to the database system, the timer will read "OL", which stands for "On Line". If your timer does not read "OL" check your cable connections to the timer. Note: The Sun Capsule timer takes a CAT-5 cable adapted to the RJ22 cable.
5. If your 'manager' is not recognizing the Sun Capsule timer and the timer does reads "OL" when the "Set Time" button is pressed, then reset power to the manager by unplugging it and plugging it back in. Also shut down the computer software and start it back up. After the manager and software re-scan, it should pick the timer back up.

## **Cooling Fan Will Not Come On:**

1. Verify the fan has not come unplugged from the junction box on top of the unit.
2. Verify the fan shut-off switch has not come unplugged from the junction box on top of the unit. This switch will stop the fan from running when the door is opened during a tanning session or during the delay period (factory pre-set at approximately 4 minutes) after a tanning session. This switch will allow the fan to resume once the door is closed, provided the pre set fan delay time has not expired . Close the door completely, or manually push the switch in with your finger while a tanning session is running. If the fan does not come on, a service technician should inspect to see if the fan delay timer inside the number 5 lamp fixture is faulty.
3. There are two 5-amp circuit breakers on the control panel on the inside of the Sun Capsule. One of these breakers protects the fan motor. Check to see if one of the breakers is popped out. If so, push the breaker back in and restart the unit. If the breaker pops out again, a service technician should inspect to see if you have a 'short' in the wiring going to the fan motor or if you have a faulty circuit breaker.

Cut along dotted line and mail warranty card back withing 15 days of delivery.

**Mail Warranty Card To:**  
Creative Marketing Concepts  
96 Audubon Road  
Wakefield, MA 01880

*Sun Capsule Limited Warranty Card*  
**IMPORTANT: MAIL WARRANTY REGISTRATION NOW**

NAME OF PURCHASER \_\_\_\_\_ DATE PURCHASED \_\_\_\_/\_\_\_\_/\_\_\_\_

NAME OF BUSINESS \_\_\_\_\_

ADDRESS \_\_\_\_\_ PHONE (\_\_\_\_) \_\_\_\_\_

CITY \_\_\_\_\_ STATE \_\_\_\_\_ ZIP \_\_\_\_\_

Email \_\_\_\_\_

PURCHASED FROM \_\_\_\_\_

ADDRESS \_\_\_\_\_

CITY \_\_\_\_\_ STATE \_\_\_\_\_ ZIP \_\_\_\_\_

MODEL NUMBER \_\_\_\_\_ SERIAL NUMBER \_\_\_\_\_

COMPLEMENTS/CRITICISMS \_\_\_\_\_

# Limited Warranties

Creative Marketing Concepts, Inc., (the company) makes the following limited warranties (the "Limited Warranties") on its artificial sun tanning booth (the "Product"). These Limited Warranties extend to the original purchaser only; they do not extend to any other purchaser or transferee.

Limited Ninety (90) Day warranty on Parts and Labor ("Limited Ninety (90) Day Warranty"). The company warrants the parts contained in this Product against defects in materials and workmanship for a period of ninety (90) days after the date of original purchase. During this period the company will repair or replace, at its option, a defective part without charge to the original purchaser with the following exceptions:

- 1) Fluorescent lamps and starters are warranted against defects for a period of thirty (30) days from date of sale.
- 2) Only parts obtained through the company, its authorized dealers or distributors may be used. Transportation costs for parts shipped to the consumer and the return of defective parts to the company are not included.
- 3) Labor will be furnished without charge for ninety (90) days from date of purchase only. All labor and related charges must be authorized by the company prior to start of repairs, and must coincide with the company's established rates and time allotment policy.

Limited One Year Warranty on Parts ("Limited One Year Warranty"). The company warrants the electrical components contained in this product (except sun lamps and starters) against defects in materials and workmanship for one year to the original purchaser of the product. During this period, the company, will repair or replace, at its option, a defective part without charge to you. You must prepay all transportation and insurance charges to and from the company service location and, after the first 90 days, you must pay all labor charges involved in repairing or replacing the defective part. FAILURE TO RETURN DEFECTIVE PART WITHIN 30 DAYS OF RECEIVING REPLACEMENT PART WILL VOID WARRANTY.

Limited Lifetime Warranty on Framework (Limited Lifetime Warranty). The company warrants that all framework components, i.e. floor, ceiling, wall panels, framework, fixture housings, guards and anything not considered electrical in nature are covered by a Limited Lifetime Warranty against defects in materials and workmanship to the original purchaser. During this period the company will repair or replace, at its option, a defective part without charge to you. You must prepay all transportation and insurance charges to and from the company service location, and after the first 90 days, you must pay all labor charges involved in repairing or replacing the defective part. FAILURE TO RETURN DEFECTIVE PART WITHIN 30 DAYS OF RECEIVING REPLACEMENT PART WILL VOID WARRANTY.

## CONDITIONS OF LIMITED WARRANTIES

It is imperative that the original customer completes and returns the enclosed warranty card within 10 days after purchase to insure valid registration and coverage for potential claims.

If the warranty card is not registered, proof of purchase from the company or its authorized dealer or distributor will be required prior to any consideration on warranty claims. This could result in service delays.

These warranties extend to the individual or legal entity, whose name appears on the warranty registration card filed with or whose name appears on the original sale document and may not be transferred to any other individual or legal entity.

These warranties do not apply to any failure of the product, or any parts of the product due to alterations, modifications, misuse, abuse, accident, improper maintenance, improper installation, normal wear and tear, discoloration of any materials or components due to UV light exposure or if the serial number on the product has been removed, altered or defaced. Adequate packaging must be used for returned goods to prevent freight damage.

THE COMPANY MAKES NO WARRANTIES (INCLUDING ANY WARRANTIES AS TO MERCHANT ABILITY OR FITNESS FOR A PARTICULAR PURPOSE) ON THE PARTS LISTED ABOVE. YOU ARE LIMITED TO THE WARRANTIES OF THE RESPECTIVE MANUFACTURERS OF THESE PARTS (IF SUCH WARRANTIES AVAILABLE TO YOU).

ALL WARRANTIES IMPLIED BY STATE LAW, INCLUDING THE IMPLIED WARRANTIES OF MERCHANT ABILITY AND FITNESS FOR A PARTICULAR PURPOSE, ARE EXPRESSLY LIMITED TO THE DURATION OF THE LIMITED WARRANTIES SET FORTH ABOVE. Some states do not allow limitations on how long an implied warranty lasts, so the above limitation may not apply to you.

WITH THE EXCEPTION OF ANY WARRANTIES IMPLIED BY STATE LAWS AS HEREBY LIMITED, THE FOREGOING EXPRESS WARRANTIES ARE EXCLUSIVE AND NO OTHER EXPRESS WARRANTIES ARE GIVEN AND NO AFFIRMATION OF THE COMPANY, BY WORDS OR ACTION, SHALL CONSTITUTE A WARRANTY.

IN NO EVENT SHALL THE COMPANY BE LIABLE FOR CONSEQUENTIAL OR INCIDENTAL DAMAGES. Some states do not allow the exclusion or limitation of incidental or consequential damages so the above limitation may not apply to you.

No person, agent, or employee of the company is authorized to change, modify or extend the terms of these Limited Warranties in any other manner what so ever. These Limited Warranties give you specific legal rights and you may also have other rights which vary from state to state.



96 Audubon Road, Wakefield MA 01880 TEL: 978/532-7517 FAX: 978/532-8168



96 AUDUBON ROAD  
WAKEFIELD MA 01880

TEL: 978/532-7517

FAX: 978/532-8168

[www.suncapsule.com](http://www.suncapsule.com)